

ICT Infrastructure business planning toolkit

2019



ICT infrastructure business planning toolkit

2019

Acknowledgments

This report was prepared by the International Telecommunication Union (ITU), by ITU experts Tiago Sousa Prado, Priscila Honório Evagelista, and Abraão Balbino e Silva, under the supervision of the ITU Telecommunication Development Bureau (BDT).

ISBN

978-92-61-28871-6 (Paper version)

978-92-61-28881-5 (Electronic version)

978-92-61-28891-4 (EPUB version)

978-92-61-28901-0 (Mobi version)



Please consider the environment before printing this report.

© ITU 2019

All rights reserved. No part of this publication may be reproduced, by any means whatsoever, without the prior written permission of ITU.

Our increasingly digital society, built around high-speed always-on access to services, applications and content, depends on ubiquitous, affordable, modern, and resilient ICT infrastructure.

Extending broadband Internet access to unserved and underserved populations to fast-forward progress towards the UN Sustainable Development Goals is one of the core pillars of telecommunication and ICT public policy and regulation around the globe.

At the end of 2018 ITU revealed that, for the first time, more than half the global population now uses the Internet. While that figure is encouraging, we must remember that half the world connected also means half the world *unconnected*.

Chronic lack of network infrastructure is one of the principal reasons – a dearth of transport networks, access networks, the inability of end-users to acquire terminal devices and equipment, or even to pay for services if they are available – all translate into a lack of providers willing or even able to offer access and services.

Putting in place the right regulatory arrangements, connectivity measures and appropriate tools to foster infrastructure deployment, particularly in rural and remote areas, is vital to promoting full digital inclusion through universal access to fast, reliable online technologies and services.

This new toolkit offers regulators and policymakers a clear and practical methodology for the accurate economic evaluation of proposed broadband infrastructure installation and deployment plans. We believe that the expert guidance offered here will greatly facilitate the development of a credible and coherent business plan that is adaptable to a wide range of broadband infrastructure deployment projects.

I hope that this new toolkit will quickly come to be recognized as an invaluable manual for regulators and policymakers everywhere, in their efforts to bring broadband networks and access to all.



Doreen Bogdan-Martin
Director, ITU Telecommunication Development Bureau

Table of Contents

Foreword	iii
1 Broadband business planning	1
1.1 The business plan	4
1.2 Challenges in developing a business plan	7
1.3 Business planning as a public policy tool	8
2 Estimating demand for broadband services	9
2.1 Estimating demand through econometric methods	11
2.2 Estimating demand through the Delphi method	13
2.3 Decomposition of demand into different segments	14
2.4 Estimating the market share of the potential new operator	16
3 Estimating revenues from broadband service provision	18
3.1 Estimating revenue for mobile broadband projects	18
3.2 Estimating revenue for fixed broadband projects	18
3.3 Estimating revenue for transport network projects	20
3.4 Revenue behaviour throughout the project	20
4 Estimating investments in broadband networks (CAPEX)	20
4.1 Mobile broadband access networks	21
4.2 Fixed broadband access networks	27
4.3 Transport networks	36
5 Estimating operational expenses (OPEX) for broadband service provision	37
5.1 Using cost models to estimate OPEX	37
5.2 Using past costs and expenses to estimate OPEX	40
5.3 Using benchmarks to estimate OPEX	41
6 Estimating weighted average capital cost (WACC)	43
7 Financing mechanisms to enable broadband infrastructure projects	50
7.1 Project and licensing financing mechanisms	51
7.2 Infrastructure deployment financing mechanisms	52
7.3 Service provision financing mechanisms	52
8 Conclusions	53
List of acronyms	55
Bibliography	57

List of tables, figures and boxes

Tables

Table 1: Comparison of broadband penetration and population within fibre reach	2
Table 2: Examples of questions for a Delphi questionnaire	14
Table 3: Operation and maintenance costs	39
Table 4: Total OPEX	39
Table 5: Total OPEX	41
Table 6: Total OPEX	42
Table 7: Pros and cons of the local vs. global CAPM	45

Figures

Figure 1: ITU Transmission Map: Terrestrial information highways (December 2018)	1
Figure 2: Regression curve (broadband penetration x GDP per capita)	12
Figure 3: Example of decomposition of mobile broadband demand	15
Figure 4: Example of decomposition of fixed broadband demand	16
Figure 5: Scheme for estimating net revenue	18
Figure 6: LTE heterogeneous network	21
Figure 7: FTTH network topology	27
Figure 8: SSL geometric model	31
Figure 9: Total costs composition	38
Figure 10: Expenses/net revenue ratio	39
Figure 11: Historical expenses / net revenue ratio	40
Figure 12: CAPEX / OPEX ratio	41
Figure 13: Unit OPEX	42
Figure 14: Steps 1 to 4 of the NPV calculation	48
Figure 15: Steps 5 and 6 of the NPV calculation	48
Figure 16: Distribution of typical infrastructure project financing mechanisms	51

Boxes

Estimating the market share of a potential new operator	17
Estimating revenue for fixed broadband projects	19
Macrocells	23
Small cells	25
Optical line terminals	29
Optical fibre calculation (splitter layer)	30
Optical fibre calculation (homes passed)	34
Using cost models to estimate OPEX	40
Using past costs and expenses to estimate OPEX	42
Estimating the WACC through a global CAPM method	46
Net present value (NPV) calculation	50

1 Broadband business planning

Introduction

Broadband network development and deployment necessitates huge investments. Given the widely differing physical and economic environments in which service providers must operate, much of this investment – from R&D to specialized equipment able to function in extreme conditions – is aimed at making it possible to deploy and successfully operate ICT network infrastructures in a range of markets worldwide.

In economically attractive areas, such as large towns and cities, infrastructure implementation happens almost naturally, because market forces act to meet demand. The picture, especially in rural and remote areas however, is often quite different, where economic, geographic and/or demographic barriers limit access to broadband network infrastructure; the result is large numbers of people remaining isolated from the digital world.

Regulators and policymakers have sought mechanisms to expand broadband networks through various strategies such as public funds, universal service funds, public-private partnerships, reduction in the reserve price of radio-frequency spectrum, and other subsidy mechanisms. Such objectives are generally focused on the construction and provision of networks in areas considered to have low economic attractiveness, where market forces alone are not able to provide services without some type of subsidy to encourage investment.

The digital gap

While technologies exist that are capable of offering services in remote and isolated areas, and newer technologies are being developed specifically to address such needs, connecting the second half of the world's population has remained an intractable problem, with some fundamental underlying challenges: The ITU Interactive Transmission Map 2018¹ dramatically illustrates the persistent lack of high-speed backbones in much of the world.

Figure 1: ITU Transmission Map: Terrestrial information highways (December 2018)²

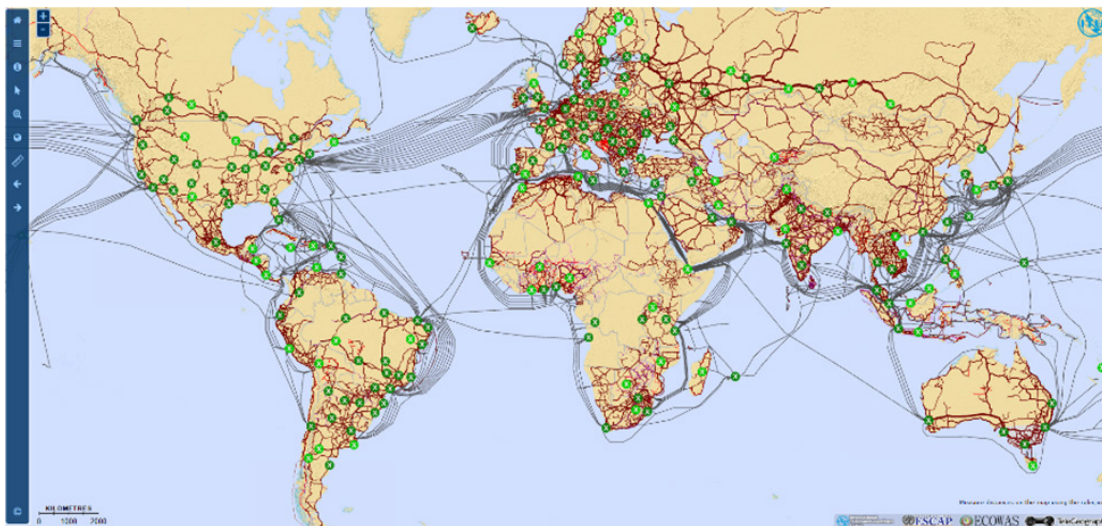

Source: ITU

¹ ITU ICT Infrastructure Mapping for Achieving the Sustainable Development Goals, available at: <https://itu.int/go/map-public>

² Source: ITU: <https://itu.int/go/Maps>

In addition, a comparison of broadband penetration and population within reach of fibre connections reveals that billions of people continue to live in countries and regions that are still not connected to this global terrestrial transmission network.

Table 1: Comparison of broadband penetration and population within fibre reach

	Africa	Arab States	Asia and Pacific	CIS	Europe	Americas	World
Individuals using the Internet	24.4%	54.7%	47.0%	71.3%	79.6%	69.6%	51.2%
Fixed broadband subscriptions	0.6%	5.1%	13.6%	19.0%	31.3%	20.6%	14.1%
Active mobile broadband subscriptions	29.7%	62.7%	68.3%	79.2%	93.6%	97.1%	69.3%
Population within 10 km of fibre node	23.6%	23.3%	20.0%	35.1%	58.1%	40.6%	27.2%
Population within 25 km of fibre node	47.5%	53.8%	47.2%	65.9%	87.5%	75.1%	55.4%
Population within 50 km of fibre node	68.6%	78.3%	70.3%	82.9%	96.9%	90.1%	75.9%

Source: ITU Key 2005 – 2018 ICT Data

https://www.itu.int/en/ITU-D/Statistics/Documents/statistics/2018/ITU_Key_2005-2018_ICT_data_with%20LDCs_rev27Nov2018.xls

Using its increasingly complete map of the world's transmission networks, ITU calculates that of an estimated global population of 7.5 billion³, 2.0 billion people (27.2%) lived within 10 km of a fibre node, 4.2 billion (55.4%) within 25 km, 5.7 billion (75.9%) within 50 km, and 6.8 billion people (90.5%) within 100 km of an operational optical fibre network node. By contrast, 5.5 billion people lived beyond a 10 km range, 3.3 billion beyond 25 km, 1.8 billion beyond 50 km, and 710 million people beyond 100 km of a working optical fibre node.

Public policy with regard to broadband network access should not be concerned only with identifying infrastructure gaps and mandating service provision, it must above all be focused on better ways of identifying possible sources of financing and more effective strategies for encouraging and facilitating service provision.

While there has been much discussion around this issue, including many studies, and proposed benchmarks and suggestions for new public policy analytics aimed at promoting broadband development, the best strategy always involves an in-depth understanding of each specific project. For example, what would be the best approach to provide broadband services to a particular rural population – satellite or terrestrial infrastructure? Or, again, how might one determine the economic viability of deploying an optical fibre backbone in a given city?

There is therefore a clear need to identify, quantify and objectively compare different infrastructure projects in order to evaluate a given public policy based on solid technical parameters. But in many countries regulators and policymakers are often unaware of specific methodologies for performing this task, and instead rely on mechanisms that are not necessarily the most efficient for such assessments, culminating in problems of insufficient or even sometimes overestimated infrastructure construction for a specific area.

³ November 2018 data.

Broadband business planning for infrastructure installation and deployment

This toolkit offers regulators and policymakers a methodology aimed at delivering an accurate economic evaluation of proposed broadband projects. It aims to serve as a practical tool to facilitate the thorough evaluation of infrastructure installation and deployment plans.

The toolkit comprises a set of theoretical principles as well as practical guidelines on how to estimate the net present value of a project. More specifically, it looks at mechanisms that identify the demand for a project, its operating and maintenance costs, resulting revenues, the amount of investment needed, and the identification of all necessary capital costs.

The economic and accounting concepts used in this methodology are widely accepted and documented; as such, it is not proposed to dissect or debate them further. Instead, they have been used to create a practical guide to develop a strategy to build broadband infrastructure and evaluate the business plans of potential operators: What types of data to use? How to assess variables like demand, investments, and operational costs? How to estimate the cost of capital for different project elements?

To promote a more concrete understanding, examples are given of common projects, such as the construction of optical fibre backbones, 4G LTE (Long Term Evolution) wireless broadband networks, and fibre-to-the-home (FTTH) access network projects.

For clarity, this toolkit is divided into the following sections:

- 1) Broadband business planning principles.
- 2) Estimating the demand for broadband services.
- 3) Estimating revenues from broadband service provision.
- 4) Estimating investment needs for broadband networks – capital expenses (CAPEX).
- 5) Estimating operational expenses (OPEX) for broadband service provision.
- 6) Estimating the weighted average cost of capital (WACC).
- 7) Estimating the net present value (NPV) of broadband infrastructure projects.
- 8) Financing mechanisms.

The first section outlines the theoretical principles and methodology for estimating a project net present value. This is presented as the basis for the construction of any business plan for broadband service provision. The section also discusses why this methodology can be adopted by regulators and policymakers in the economic evaluation of different types of broadband projects.

In the second section, models and techniques for demand estimation for broadband services are discussed, along with which types of raw data can be used. Questions covered in this section include: How can policymakers estimate the demand for a service? How might this evolve over time? How might this demand be met by the existing competitive environment?

The third section deals with the estimated revenue generated by the project in question. This variable is fundamental, because it defines when and how inputs are implemented in an infrastructure project. The section gives examples of how to estimate revenue, how to match it to estimated demand, and how it can vary over time.

The fourth section deals with capital expenditure modelling. This variable is crucial to the whole ecosystem, and this is where the infrastructure of the project in question will be modelled: types of equipment, theoretical bases, and practical suggestions for modelling investments over time for various types of project are all addressed.

The fifth section deals with operating expenses. Which variables matter in modelling a broadband network? Where does one get this information? What is the best approach regulators and policymakers can use to model the operational costs of a project?

In the sixth section we look at the weighted average cost of capital, which represents the discount rate of the project to be analysed. What does this rate mean? Why is it so important? How can it be estimated in the absence of concrete data? This section provides a practical orientation to calculating this complex variable.

The seventh section of the toolkit is a summary that provides guidance on combining all variables into a single tool in order to estimate the project net present value.

The eighth and final section discusses financing mechanisms and looks at different viable alternatives that can be adopted in broadband public policy.

This toolkit will serve as a practical and invaluable manual for regulators and policymakers working towards extending broadband network deployment and access. ICT network operators will also use their own complementary project appraisal tools to meet the specific needs of management and company shareholders, but this toolkit will serve all as a basic, understandable guide to building a credible and coherent business plan adaptable to a wide range of broadband infrastructure projects.

1.1 The business plan

A business plan is a planning tool in which the main variables involved in establishing and operating an enterprise are presented in an organized way. There is no single, rigid and specific structure for drawing up a business plan. However, a good business plan should include a minimum of aspects that need to be analysed in order to provide an understanding of the activity in question.

The objectives that guide the implementation of a business plan for broadband installation and deployment should contain an accurate assessment of the key variables that make up the business. Consequently, excepting elements such as taxation scales, which will be defined in the relevant legal instruments of each country, business variables such as demand, revenue, investment, expenditure and cost of capital can and should be studied and estimated in such a way that the final result reflects the value of the project in question.

In addition, the importance of analysing the competitive environment in which the business will operate should not be overlooked, since this will have a significant bearing on issues such as demand and revenue allocated to the project.

The most often used approach to evaluate the economic value of a telecommunication asset is from a cash flow perspective. According to this view, the price of the asset (e.g. radiofrequencies) should be proportional to the economic result that the business will create by using the asset during a pre-determined period of time.

The net present value (NPV) of free cash flow (FCF) is a methodology used to evaluate specific companies and projects. The approach is widely used by investment banks, consultancies and entrepreneurs when they wish to calculate the value of an organization, or one of its businesses, whether for internal purposes, investment analysis, or for mergers and acquisitions.

In this approach, the value of a given business is determined by discounted cash flow at a rate that reflects the risk associated with the investment. The NPV model incorporates three fundamental general principles to establish an optimal investment decision criterion:

- i. the valuation of the investment is calculated based on operational cash flows;
- ii. the risk is incorporated into the economic evaluation of the investment, respecting the preferences of the investor with respect to *risk-return conflict*;

- iii. the resulting calculation identifies the present value of the assets based on the appropriate discount rate to remunerate the capital owners.

Based on this analytical framework, regulators can use a standard set of financial tools to calculate the value of any given project according to the market conditions.

Net present value, calculated by the discounted cash flow method, reflects the amount obtained by a company in a given project that exceeds the cost of investment made, already duly remunerated by a certain rate of return – by the opportunity cost of capital. In other words, it is the profit that the entrepreneur could obtain, discounting the opportunity cost and the consequent profitability that the entrepreneur could have obtained through pursuing other activities.⁴

The NPV calculation takes into account estimates of all revenues and expenses for each year of the business throughout the duration of the project, as well as the total investment needed to implement the service.

In other words:

$$NPV = \sum_{t=0}^T \frac{FCF_t}{(1+r)^t}$$

where:

NPV = net present value

FCF_t = free cash flow in the period *t*

r = Discount rate (WACC)

t = number of periods

A general model for the calculation of free cash flow for a certain period of time is:

$$FCF = \{[(EBIT(1 - tax\ rate))] + De + Am\} - CAPEX$$

and

$$EBIT^5 = revenue - OPEX$$

where:

De = depreciation

Am = amortization

tax rate = tax rates involved

CAPEX = capital expenditure

OPEX = operational expenditure

The following is a brief summary of what each of these variables means; the following sections will present a practical and detailed method for estimating them.

⁴ From a financial point of view there are other interesting methodologies for evaluating companies and businesses. Indicators such as payback, internal rate of return (IRR) or return on investment (ROI), for example, are also used by companies seeking to evaluate projects. From the point of view of this toolkit, which is designed as a practical guide for regulators and policymakers, it is important to understand the methodology as a basic concept that is sufficient for the purpose of comparing broadband infrastructure projects.

⁵ EBIT: earnings before interest and tax.

Demand

The variable *demand* plays a particularly important role in any business plan, since this data defines the market dimension of the proposed business. The determination of other variables such as investment, revenues and expenses is inextricably associated with demand forecasting.

At this point, it is important to emphasize that the evaluation of demand behaviour occurs within a delimited timeframe that, for our purposes, comprises the project timeframe. A regulator thus requires not only a precise notion of the business that targets the desired service offering, but also the potential users of the service and how that potential might evolve over time.

For this, statistical data on income, predisposition to spending, and the socio-economic conditions of the target public of the business will be fundamental to building an accurate model of demand estimation. These data are the sources used by all those who seek a business potential assessment; it goes without saying that the more accurate the modelling, the more robust will be the final evaluation.

Revenues

When calculating potential business revenues, a good knowledge of the current conditions of service provision is essential. Benchmarking of other markets, as well as factoring in the existence of substitute products (i.e. products that will compete directly with those of the proposed new business) are essential for any accurate analysis.

The final estimation of revenue should include the full portfolio of products, such as data services, voice, etc. At this point, knowing the average revenue per user (ARPU) history is critical to building a consistent model, especially when the project proposes a service that is already provided. Any analysis must be consistent with the socio-economic conditions of the area in question, so consideration of pre-existing demographic studies relating to expenditure is desirable.

Operational expenditure (OPEX)

This variable corresponds to all operating expenses of the modelled business, known collectively as OPEX. Calculation of this variable is difficult for regulators, since there is generally no detailed public data available that could favour its measurement.

In the absence of data, regulators will need recourse to specific studies of the business in question, noting the main technologies available for the implementation of the projected infrastructure as well as the balance sheets of companies that provide similar services, such as mobile operators in other frequency bands.

In addition, regulators can use accounting data received from local service providers to complement analysis of the composition of these expenses.

Another important aspect to consider is the behaviour of expenses over the term of the licensing period. As the proposed business, in theory, is not yet operational, the study in question will relate to a new provider where demand starts small and grows over the years. As a result, the expenditure curve will follow a behaviour proportional to the estimated demand.

However, factors such as marketing expenses tend to behave in accordance with the investment curve, owing to the fact that they are linked to the availability of the business in a given location.

Investments (CAPEX)

Investments represent one of the main pillars of any project business plan. This variable, commonly referred to as CAPEX (capital expenditure), essentially covers investments in all networks and systems infrastructure required for the provision of services. It is thus important for the regulator to have enough technological knowledge to obtain quotations from suppliers for the relevant technologies

and equipment in order to simulate the construction of a hypothetical network capable of meeting the projected demand outlined in the business plan.

Finally, for modelling purposes, it should be noted that the proposed infrastructure must meet the estimated demand over time, so aspects such as reinvestment and technological substitution need to be considered.

1.2 Challenges in developing a business plan

The key question for regulators and policymakers when designing a project evaluation plan following this methodology is how to estimate each of the variables outlined above. Whether due to information asymmetry or uncertainty about the future behaviour of a particular business, conducting a study that accurately estimates these variables is no easy task.

The number of variables involved, as well as their behaviour over time, can make modelling highly complex, and accurate project costing can become an unworkable task if not supported by a robust methodological basis and by sufficient disaggregated data.

Since regulators and policymakers normally have a partial knowledge of these variables and data, the standard approach is to make rough estimates of each variable following reliable statistical and/or econometric predictive methodologies.

This raises a fundamental question: What is the credibility of a prediction-based study aimed at identifying the feasibility or otherwise of a public policy? The answer lies in the fact that the executing agent of this policy will normally be using the same methodology to make its own estimates, so there are approaches that can reconcile these issues. To reduce the information asymmetry between the regulator and the private sector three different strategies can be employed:

- i. comparing or cross checking the company accounts known by the regulator (e.g ARPU, MOU, RPM) with the company basic accounts;
- ii. using public auction documents, since the regulator can define a reference price and the final price after the bid may reveal the information asymmetry;
- iii. publishing the project (e.g. in public consultations) enabling everyone to contribute to the prediction-based model proposed by the public agent.

It is a regulator task to make a careful methodological evaluation to mitigate any asymmetries between the premises contained in the study on which the project business plan is based.

Another fundamental question is the need for *auditability*. Regulators and policymakers are constantly subject to monitoring by various authorities, consumer bodies and the media. To ensure transparency and auditability, each plan needs to be accompanied by open data and theoretical models robust enough to avoid criticism or attack based on the perceived arbitrary adoption of questionable values for discretionary variables.

There is a difference between private agents, who knows their costs, revenue goals and projects, and a public agent. When developing a plan, a private agent has full knowledge of the variables in question, and can use them (or not) when communicating with shareholders without the need to guarantee a certain level of robustness or auditability for some of the variables involved.

On the other hand, in making an estimate of cash flow for a given business, a public agent, besides having an asymmetry of information to estimate the project, must also be neutral and auditable enough to guarantee the levels of reliability and transparency that the process requires.

In addition, depending on the institutional and legal framework of the country concerned, it is frequently the case that public policies must be submitted, evaluated and audited by oversight bodies, such as Courts of Accounts or external auditors, including in some cases the justice system. This

situation demands that business plans developed by the regulator / policymaker must be sufficiently robust not only to meet approval, but to serve as future social and legal points of reference.

Some important recommendations flow out of this. The regulator / policymaker conducting the study needs to:

- **Use as much open data as possible:** Using open data brings transparency; it is easy to track and to understand estimates.
- **Base studies on recognized sources:** Every business plan is based on sources. However, the credibility of these sources is critical. Sourcing information, data and analysis from international organizations or entities or well-known authors will confer more robustness on the plan.
- **Use auditable tools:** The set of interrelationships between all variables that make up a business plan is very large. Because of this, it is crucial that models be developed in a trackable way so that any faults are corrected. A small error not properly mapped can make a viable project unfeasible – and vice versa.
- **Be conservative in making estimates:** Every business plan has levels of uncertainty. Whether due to information asymmetry or a necessarily high number of future projections, scenarios leading to a range of results are common. In view of this, it is prudent to make conservative choices to allow for a certain margin of error without fundamentally undermining the project.

1.3 Business planning as a public policy tool

When a project has a positive economic return (i.e. returns a positive NPV), it can be reasonably expected that it would be executed at some point without the need for government action or intervention in terms of, for instance, subsidy. Traditionally, regulators and policymakers assess the need for government incentives towards fostering network deployment and service provision in a given unserved region as a problem of maximization of social welfare. Such assessment is grounded on the premise of economic regulation that the regulator or policymaker should stimulate service provision under conditions of zero economic return. It means, a company should have its invested capital fairly remunerated by the average market cost of capital. A service provision at this point would maximize the social welfare.

Two strategies are generally used to achieve such maximization: the promotion of competition, and the regulation of pricing. In competitive markets, prices naturally move towards economic efficiency. When competition is not present, some regulatory intervention in pricing is frequently required in order to try to reproduce the results of a competitive environment.

On the other hand, projects with negative economic return start out from the position of economic unfeasibility, with the degree of unfeasibility generally determining the need and extent of public policy action if the project is considered necessary by policymakers.

Private agents usually choose their projects according to the promise of economic return. They prioritize projects strategically from the results of their analysis of proposed business plans and, in general, do not execute projects with negative NPV, since they bring losses to the business overall. Negative NPV projects therefore tend not to be executed, and the geographic areas associated with them, such as rural and isolated communities, tend to be neglected due to economic unfeasibility and unprofitability.

It is in this context that this toolkit seeks to help regulators and policymakers appraise the overall value to society of projects that are not immediately economically compelling. Since a public policy is nothing more or less than an initiative of what the public decides to do (or not do), the decision to assess the viability of a broadband infrastructure project that is not in itself economically profitable means it is already considered a project of public interest. From there, identifying the *extent* of project

non-viability becomes a crucial question, since the answer may define or even prevent its eventual implementation.

At this point, many regulators and policymakers are prone to technical misconceptions that need to be remedied. For example, it is a common assumption that the feasibility of investing in a given project should be based only on the estimation of the investment costs (CAPEX) involved in a project. For example, if coverage of a given area through access to a 4G LTE wireless infrastructure would be made possible by a CAPEX of USD 10 million, it is often understood that this is the exact amount that would need to be funded by the policy sponsor. From a financial point of view, this is a serious fundamental error, because:

- i) it takes into account just one variable of the business, neglecting other crucial considerations;
- ii) it does not look at the business over time.

A true and accurate assessment of the feasibility of an investment needs to look at all the variables of a given project. For example, a project may be economically non-viable, not only because investment costs are high, but because projected revenues will be insufficient to recoup total costs. Or, conversely, revenues may be plentiful, but the ongoing costs of operation and maintenance combine to make the project economically unfeasible.

With this in mind, the best mechanism to measure the extent of economic unfeasibility is analysis of its NPV, since this accurately measures all the variables of a business, evaluated over time, and indicates the economic return gap – giving regulators a comprehensive picture of the causes of economic unfeasibility.

For a precise evaluation of a broadband infrastructure public policy project, it is necessary to construct a business plan with a sufficient time horizon for the development of the business and evaluation of its behaviour.

The following sections of this toolkit will now look in-depth at each business variable.

2 Estimating demand for broadband services

A key part of any business plan is to estimate demand for the services that will be offered. Failure to use reliable demand estimation instruments means policymakers risk launching a public policy that does not address the actual needs of the population. For example, a government may decide to invest in an optical transport network in a municipality in order to respond to perceived increasing demand for ultra-broadband access networks. However, due to socio-economic factors, the municipality may not see sufficient demand to warrant an optical fibre transport network. If the level of demand had been better identified, the policymaker could have chosen a project that would have reflected the needs of the municipality.

Understanding the drivers of demand is crucial to the success of any demand estimation. Demand estimation methods are typically accurate for short-term business planning. Estimating demand over the longer term is a bigger challenge, because there are many unforeseen factors that inevitably influence demand over time, especially in the fast-evolving telecommunication sector. For example, demand estimation might not take into account services that suddenly arise with new technologies. Economic recession, political disruptions or other financial problems also affect demand. To forecast long-term demand, policymakers must account for the social, political and economic history of their countries and have a deep understanding of demand drivers. These insights can sometimes prove the difference between a successful project and a failure.

Of course, accurate demand estimation alone cannot guarantee a successful project. But without it, decisions on investment, operational costs, revenues and other resource allocation can be based

on hidden, unconscious assumptions – assumptions that may often be proved wrong. Striving to accurately assess market demand provides a better chance of controlling the main factors that affect the project. In addition, undertaking the estimation exercise forces policymakers to rethink and analyse the market environment in which the public policy will be implemented, and improves the chances of a public policy that best fulfils the needs of a growing population.

There are multiple techniques for demand estimation. Historical data, econometric methods, interviews and experimental tests are all commonly used methods for estimating the potential demand for a service.

In stable markets demand can usually be estimated using econometric models with a focus on price elasticity estimation. A stable market for a particular telecommunication service can be considered one in which that service has already been operating for many years.

There are many academic publications covering demand estimation for fixed and mobile telecommunication services. In general, they estimate the aggregate demand of a service using models based on time series data or cross-sectional data. The main drivers used to estimate demand are:

- price;
- income;
- purchasing power parity;
- teledensity;
- household demographics.

Estimating the demand for access and use of services mostly employs price and income as demand drivers. This type of demand model can be used for different countries as long as independent variable data from the country in question is used. Estimating price elasticity is likely to be dependent on income, trade patterns and various cultural aspects within a country. For this reason, estimated price elasticity is always country-specific.

Databases of county profiles, world development indicators, GDP, purchasing power parity, and population estimates, can be found at the World Bank Open Data website⁶. Indicators and statistics for information and communication technologies (ICTs) can be found at the ITU ICT-Eye⁷. The ICT-Eye database is a one stop-shop for telecommunication/ICT indicators and statistics, regulatory and policy information, national tariff policies and costing practices. In addition, ITU is working on technical, economic, policy and regulatory research and collecting data on the evolution of infrastructure development and sharing world-wide, this information is available at the ITU Infrastructure Development Portal⁸.

Estimating demand for new services presents a greater challenge. New services are related to new uses and are supported by new equipment and new technologies. Although, in principle, new telecommunication service forecasting is no different from other areas, the challenge of anticipating an unexplored market has led most academic forecasters to steer clear of this area.

For new services, both pre- and post-launch, two key forecasting problems must be addressed: estimating the market potential of the various generations of service and, of equal importance, the diffusion path – that is to say, the rate and time at which the new product is adopted, which in turn gives period-by-period sales⁹. For many applications the usage rate of the new technology will also be needed. Pre-launch, the market potential and the entrants are key factors that determine

⁶ The World Bank Open Data website is available at <https://data.worldbank.org/data-catalog>

⁷ ITU ICT-Eye is available at <http://www.itu.int/net4/itu-d/icteye/Default.aspx>

⁸ ITU Infrastructure Development Portal, <https://www.itu.int/en/ITU-D/Regulatory-Market/Pages/InfrastructurePortal.aspx>

⁹ Fildes and Kumar (2002).

success, but as time goes by the churn rate (describing change of behaviour between technologies and competitors), the drop-out rate, and the usage rate become more important.

The main elements used to estimate demand for the new service are so-called intentions surveys, service feature evaluations, choice models, trial markets, and/or the drawing of analogies to other products, or even to other countries.

The data used to estimate demand for a new service are collected either through survey methods or (sometimes) through experiments. Either a range of alternative services can be considered, or the simple question asked as to whether the respondent intends to buy a particular service. A questionnaire can also be submitted to a group of experts in order to solicit a degree of professional judgment about the new service. A notable method that can be employed in the latter case is the Delphi Method¹⁰.

Most telecommunication services have generic uses, so new generations of technology both offer an existing service and expand the range of possible uses, e.g. 4G LTE mobile technology offering the same services as 3G technology. In this case, the new technology substitutes the voice services offered by 3G while expanding the range of use by supporting more advanced data applications. Market potential can thus be estimated by viewing the problem as a combination of the previous market and the new market gained as a consequence of the expanded range of uses. Econometric models can be used to estimate the aggregate demand for the services while the Delphi Method can be used to disaggregate this demand according to the attractiveness of each generation of technology.

It is important to note that inaccurate suppositions do not stem from a lack of forecasting techniques. Regression analysis, historical trend smoothing, Delphi/expert judgment, feature evaluations, trial markets, and other methodologies are available to all. Most inaccurate demand forecasts share a mistaken assumption that the complex relationships driving demand in the past will continue unaltered. Policymakers should always bear in mind that history can be an unreliable guide as new technologies emerge, consumers change preferences, industries continue to develop and the regulatory regime evolves.

2.1 Estimating demand through econometric methods

To estimate the needs of broadband in a given region, a simple regression model can be developed (similar to the original teledensity models) based on the size of the economy. This simple regression model uses current levels of broadband penetration in a group of countries, and each country's gross domestic product (GDP).

This model was used by Katz (2009)¹¹ to estimate broadband demand in Latin America. According to the model there is a positive relationship between GDP and broadband penetration, since it is expected that richer per capita countries will have a larger proportion of their population subscribing to broadband.

¹⁰ The Delphi Method consists of an estimation method that involves consulting a group of experts about a future event through a questionnaire that is passed on repeatedly until consensus is reached – see p. 29 for a fuller discussion. To learn more, see: Okoli, C., & Pawlowski, S. D. (2004) The Delphi method as a research tool: an example, design considerations and applications, *Information & management*, Volume 42 Issue 1, 15-29.

¹¹ Katz, Raul L. (2009) *Estimating broadband demand and its economic impact in Latin America*, in Proceedings of the 3rd ACORN-REDECOM Conference, Mexico City.

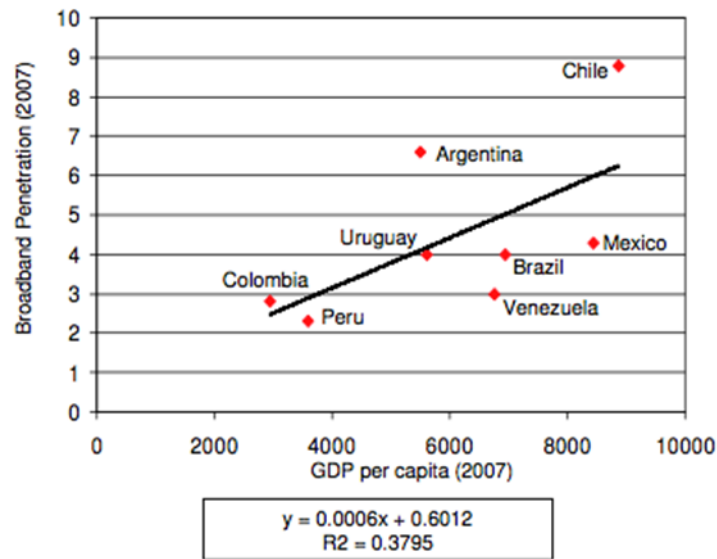
Figure 2: Regression curve (broadband penetration x GDP per capita)¹²

Source: ITU

Another easy-to-use approach was developed by the OECD and published in 2008¹³. This approach is based on a cross-sectional model and uses data from OECD countries. The OECD work found that the best model to estimate broadband demand was based on logged values of penetration, price, GDP per capita (GDPPC) and number of years since the launch of commercial digital subscriber line (DSL) services.

A useful characteristic of this model is that value of the coefficient on log (price) and log (GDPPC) can be interpreted as the elasticity:

$$\log(\text{PEN}) = \alpha + \beta \log(\text{PRICE}) + \gamma \log(\text{GDPPC}) + \delta \text{YSL} + \theta \text{YSL}^2 + \varepsilon$$

The OECD model suggests that:

- The long-run price elasticity of demand is in the inelastic range. The coefficient of -0.43 indicates that a 1 per cent decrease in price would lead to a 0.43 per cent increase in demand over the long run. Demand does not appear to be strongly influenced by price. However, this elasticity is towards the top end of the typical price elasticity of demand for telephone line rental and local and long distance calling found in developed countries.
- The long-run income elasticity of demand, measured by GDPPC, is somewhat stronger. A 1 per cent increase in wealth would lead to 0.78 per cent increase in demand, again over the long run. This is also in line with other studies on income elasticity of demand which suggest that higher income countries would have a coefficient of less than one.
- The coefficient on YLS and YLS2 indicate that growth in demand for broadband is non-linear and in the strong growth phase. As expected, the coefficient on YLS2 is negative.

This cross-sectional model can be used to estimate the penetration of service in a given country or even to estimate a new model based on the characteristics of the countries of a particular region or of countries that have some similarities with the target country, e.g. socio-economic or geographical indicators.

¹² Katz (2009).

¹³ Cadman, R. and Dineen, C. (2008) *Price and income elasticity of demand for broadband subscriptions: A cross-sectional model of OECD countries*, SPC Network 19, 03-08.

Although the models presented above were developed to estimate fixed broadband service demand, they can also be used to estimate mobile broadband service demand by substituting fixed broadband penetration and fixed subscription prices for mobile penetration and mobile subscription prices.

Regulators with access to the relevant data may also estimate service demand through panel data models. Hausman and Ros (2013)¹⁴ estimated demand models for mobile and fixed telecommunication services by using panel data of countries similar to Mexico, selecting a sample of comparable countries based on income levels (GDP per capita). Although the Hausman and Ros study used market exchange rates in the rankings, the sample of peer countries does not change if power parity index had been used. A sample spread of countries just above and just below Mexico in GDP per capita rankings was selected. The selection criteria were countries having similar levels of GDP per capita as Mexico and having availability of mobile pricing data.

The econometric models of mobile demand and mobile pricing estimated demand equations for mobile services for 17 country samples to determine the price-elasticity of demand and the GDP-per-capita elasticity of demand for mobile service in Mexico. In these demand equations, mobile penetration is the left-hand side dependent variable (that is, the researchers were measuring how mobile penetration changes when other variables, such as income and price, change).

A fixed-effect estimation approach was adopted in order to eliminate biased and inconsistent estimates. The estimated price elasticity of demand of approximately -0.50 and the estimated GDP-per-capita elasticity of demand of around 0.45 are both estimated precisely (that is, they are statistically significant) and find that economic variables have an important effect on mobile subscriptions.

The resulting models demonstrated that price and GDP per capita are both important determinants of mobile demand.

2.2 Estimating demand through the Delphi method

The Delphi methodology consists of an estimation method that involves consulting a group of experts about a future event through a questionnaire that is passed on repeatedly until consensus is reached. With a history dating back more than 50 years, this methodology is recognized as one of the best tools for long-term forecasting and is used extensively for the elaboration of public policies in a number of countries.

In the first round, questions are sent to a selected group of telecommunication industry experts. These experts are broadly drawn from national operators, equipment suppliers, academic institutions, research centres, specialized trade press, industry associations and regulatory authorities.

The first-round responses are then consolidated and analysed. The questions with the highest observed divergences (between the mean and the median of the answers obtained) are selected for the second round. In this round the average, the median and the answer given in the first round are shown to each of the experts, who are asked if they wish to maintain their original answer or change it.

After the second round the results are consolidated and, for each question, the central tendency indicator to be used in the demand projection is selected: average or median. For each question, the chosen indicator, the selection criterion and the results obtained are detailed. If the results continue to differ, new rounds can be launched. The goal is to reduce the range of responses and arrive at something close to expert consensus.

The questionnaire may approach questions such as teledensity, usage and consumption of a new service or technology, and the expected evolution of new generations of technologies. In the

¹⁴ Hausman, J. A., and Ros, A. J., (2013) *An econometric assessment of telecommunications prices and consumer surplus in Mexico using panel data*, Journal of Regulatory Economics, Volume 43 Issue 3.

questionnaire, values can be estimated for every five or ten years, for example, 2020, 2025, 2030, 2040, and 2050.

Table 2: Examples of questions for a Delphi questionnaire

#	Question	OBSERVED				ESTIMATED			
		2014	2015	2016	2017	2020	2025	2030	2050
1	Mobile-cellular subscriptions per 100 inhabitants	44%	50%	55%	65%				
2	Machine-to-machine (M2M) access per 100 inhabitants			0.02	0.03				
3	Minutos de uso (MoU) per mobile subscriber	82	91	86	109	115			
4	Mobile data usage per mobile broadband subscription			15	35	59			
5	Evolution of generations of mobile technology	99%	94%	90%					
		1%	6%	10%					
		0%	0%	0%					
		0%	0%	0%					
6	Fixed (wired)-broadband subscriptions per 100 inhabitants								
7	Optical fiber participation in total residential fixed access technologies	< 1%	< 1%	< 1%	< 1%				
8	Optical fiber participation in total non-residential fixed access technologies	< 1%	< 1%	< 1%	< 1%				
9	Average speed (in Mbps) per broadband access			170%	180%				

Source: ITU

From the consolidated results for each of the estimated years the remaining years can be estimated by linear interpolation or s-curve.

This methodology attempts to make effective use of informed intuitive judgment in long-range forecasting, and is ideal for estimating long-range demand and demand for new services and technologies.

2.3 Decomposition of demand into different segments

After estimating the aggregate demand, the next step is to divide total demand into its main components for separate analysis. The Delphi method results can also be used to help in this decomposition.

There are two criteria to keep in mind when choosing market segments: making each category small and homogeneous enough so that the drivers of demand will apply consistently across its various elements, yet making each large enough so that the analysis will be worth the effort. Here, it will be necessary to exercise its own judgment.

In making this decision it can be useful to imagine alternative segmentations – for example, based on end-use customer groups (e.g. residential or non-residential) or on type of purchase (e.g. pre-paid or post-paid plans). The next step is to hypothesize key demand drivers for each segment and decide how much detail is required to capture the true situation. As the assessment continues, this stage can be revisited and reexamined to see whether initial decisions still stand up.

In thinking about the level of the demand segmentation, it is necessary to decide whether to use existing data on segment sizes or to undertake new research to get an independent estimate. A wide range of public information on historical demand levels by segment is available for many countries

via the ITU ICT-Eye database¹⁵. Some national regulators also provide a wide range of statistics and indicators about their telecommunications sector which can also be used.

Even with good data sources, the available information may not be segmented into the best categories to support insightful analysis. In such cases, it is important to decide whether to develop the forecasts based on the available historical data or to undertake a new round of expert judgment, which can be time-consuming and expensive.

As an example, the decomposition of mobile aggregate demand could follow the structure set out in Figure 3.

Figure 3: Example of decomposition of mobile broadband demand

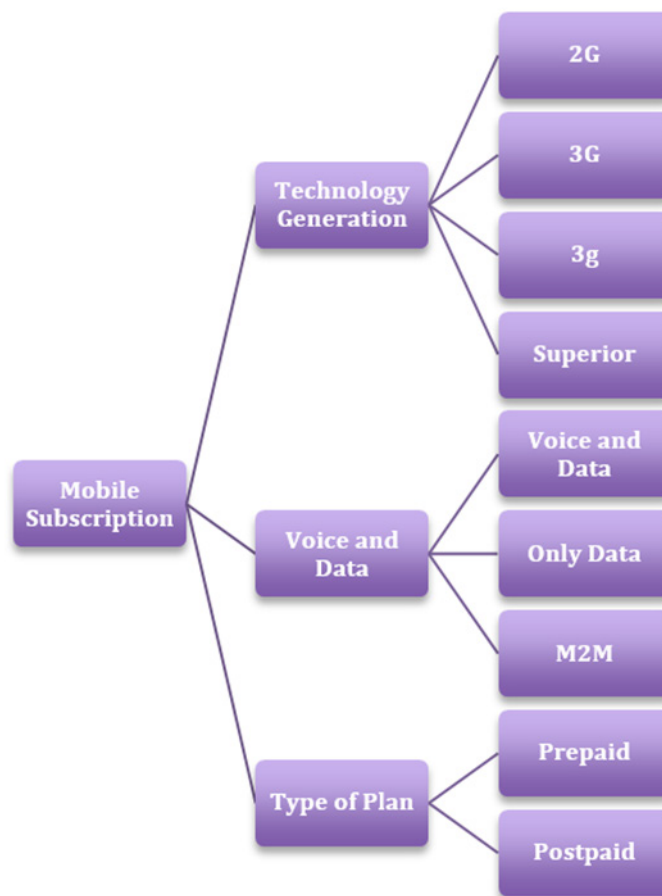

Source: Elaboration based on Fields and Kumar (2002)

The decomposition of fixed broadband aggregate demand could follow the structure in Figure 4.

¹⁵ ITU ICT-Eye is available at: <https://www.itu.int/ITU-D/icteye/>

Figure 4: Example of decomposition of fixed broadband demand

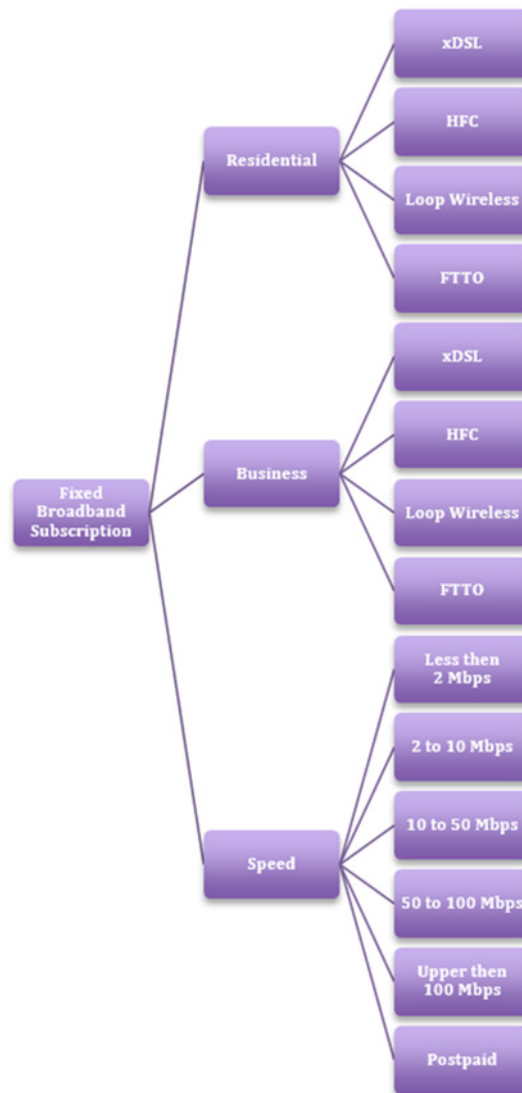

Source: Elaboration based on Fields and Kumar (2002)

When decomposing the aggregate demand, it is important for policymakers to keep in mind the public policy goal they seek to achieve, in order to have the best specification for the business plan, given the data availability.

2.4 Estimating the market share of the potential new operator

Once the demand for services has been defined, the next step is to model how the market will be divided in relation to a potential new entrant or an already established company that will implement the public policy objectives in the context of the current competitive environment.

Market modelling should always factor in the existing regulatory rules and criteria for granting service, spectrum caps, channelling of the radiofrequency band/s, and the behaviour of the current market.

When estimating the market share of a potential fixed broadband operator we should first consider the status quo of the current market players and determine whether there are any regulatory provisions in place geared to promoting competition that may impact the current competitive scenario in the medium term. If the status quo seems likely to be maintained, it is possible to simply replicate the current market share of the established operators with small variations until the end of the project.

Conversely if, in the long term, an improvement in the competitive scenario is expected, one should expect that the market share of the established operators will vary over time and that new entrants may gain market share. An S-curve to model can then be employed to forecast how market share will evolve until the end of the project.

In estimating the market share of a potential mobile broadband operator, besides factoring in the considerations above, it is necessary to take into account spectrum cap rules as well as any regulatory provisions covering mobile virtual network operators or radio access network sharing. With this information in hand it is then possible to model how the competitive scenario could evolve during the project and estimate the market share of the operator that will be implementing it, again employing S-curve models¹⁶.

Estimating the market share of a potential new operator

Scenario: A fifteen-year fixed broadband project that will be deployed by a new entrant. In this area, the telecommunication regulatory authority is promoting several competition-oriented measures aimed at achieving a long-term level of competition that would see operators divide the market almost equally. The fixed broadband market already has five operators; the new entrant will be the sixth. Its market share curve will start near to zero, but during the project that market share will evolve until it achieves the level of market share aimed at by the regulator. S-curves can be used to model the behaviour of this new entrant over the duration of the project.

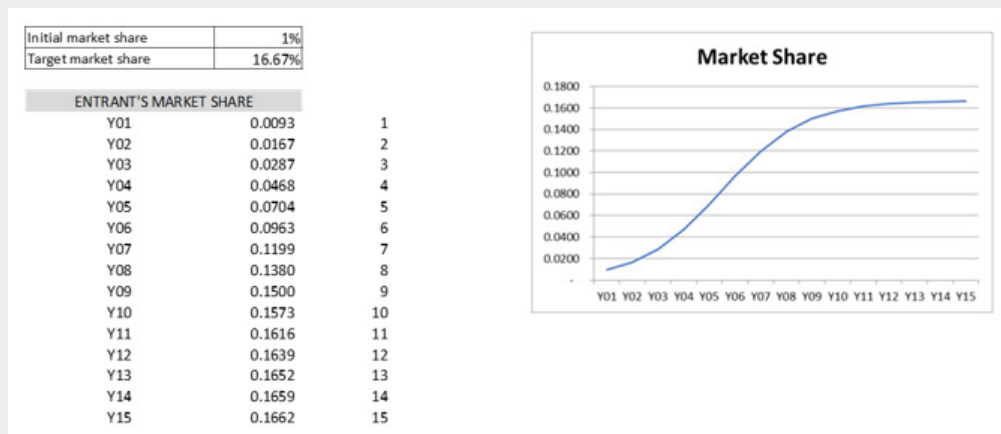

Source: ITU

Note: The values used are illustrative.

¹⁶ S-curve models may be used in the telecom/ICT sector to describe the behaviour of a new service in the market. The S-curve model is characterized by a shallow start, where only early adopters and niche markets use the service. The curve then rises sharply as the new service experiences rapid growth and gains a dominant position in the market. After this period of high growth the service maintains a high performance level but with little growth, which often signals a mature but saturated market.

3 Estimating revenues from broadband service provision

This step involves estimating the revenues associated with the projected demand. The simplest way to estimate net revenues is by calculating average revenue per user (ARPU) for the services or service segments that are to be provided under the business plan.

Once the ARPU has been obtained, it is multiplied by the estimated demand in order to arrive at the net revenue as shown in Figure 5.

Figure 5: Scheme for estimating net revenue



Source: ITU

However, it is not always possible to obtain the ARPU for the specific service to be launched, so some adjustments may need to be made, such as use the ARPU of a similar service. In addition, it is unusual for ARPU to remain constant throughout the whole project, so it will be necessary to make some assumptions in order to forecast how this might evolve during the project.

Some of the options that can be used to estimate the revenue of broadband projects are explained below, along with a proposed approach to estimate how revenues may evolve during the project.

3.1 Estimating revenue for mobile broadband projects

First of all, it should be noted that despite the fact that the project to be implemented is a mobile broadband access network, from the point of view of the end user, the project is effectively the provision of mobile communications i.e. mobile voice service and mobile data service. It is suggested therefore that the estimation of ARPU for the project is based on the ARPU of the mobile services that will be launched.

In addition, analysis reveals that despite the evolution of mobile technologies (2G, 3G, 4G LTE), there have been no significant changes in ARPU related to these new generations of technology. In general, the value of the end-user service plans has in fact remained practically the same; that is, although the service has been upgraded in terms of data volume and quality, the value paid by the user has not significantly changed. In short, over the years, for the same price users have been benefiting from greater call and message volumes and increased data usage, at higher speeds, and even with additional value-added services. For modelling purposes, what this means is that historical mobile service ARPU data can be used to estimate revenues for newer mobile broadband services.

If the data are available and it is possible to segment the demand, then segmenting ARPU into pre- and post-paid subscriptions can confer more precision on the projections.

3.2 Estimating revenue for fixed broadband projects

To estimate revenue for fixed broadband projects, it is recommended to use the ARPU for fixed broadband services. In general, service providers in the fixed broadband market offer at least two main plan profiles: a low speed and high speed profile. Nowadays, a low speed profile equates to plans up to 20-25 Mbit/s, while a high speed profile covers plans from around 25 Mbit/s and above.

Once again, if there are data available and it is possible to segment demand, segmenting ARPU into low- and high-speed plans tends to confer more precision on the projections.

Estimating revenue for fixed broadband projects

Suppose that a ten-year fixed broadband project will be deployed in country W. Operators in country W in general propose two main types of broadband offer: a low-speed offer and a high-speed offer.

The ARPU in country W is:

- low-speed offer: USD 22;
- high-speed offer: USD 48.

Over the past five years, ARPU has been declining steadily at a rate of 0.5 per cent a year. It is presumed that this trend will continue over the ten years of the project. Once total ARPU is estimated for all project years, total revenue can be estimated by multiplying the demand of a year by the total ARPU of the same year.

Note that in the first year of operation, it is recommended to consider revenues only for a six months period, since time needs to be allowed between the deployment of the network and the commercialization of services.

Evolution of Fixed-broadband ARPU				
	Low-speed offers		High-speed offers	
Y01	\$	22.00	\$	48.00
Y02	\$	21.89	\$	47.76
Y03	\$	21.78	\$	47.52
Y04	\$	21.67	\$	47.28
Y05	\$	21.56	\$	47.05
Y06	\$	21.46	\$	46.81
Y07	\$	21.35	\$	46.58
Y08	\$	21.24	\$	46.34
Y09	\$	21.14	\$	46.11
Y10	\$	21.03	\$	45.88

Fixed-broadband Estimated Demand		
	Low-speed offers	High-speed offers
Y01	25,650	1,350
Y02	43,200	4,800
Y03	90,100	15,900
Y04	132,000	33,000
Y05	183,000	61,000
Y06	221,900	95,100
Y07	248,950	134,050
Y08	283,200	188,800
Y09	319,000	261,000
Y10	368,500	368,500

Total Revenue			
	Low-speed offers	High-speed offers	TOTAL REVENUE
Y01	\$ 3,385,800	\$ 388,800	\$ 3,774,600
Y02	\$ 11,347,776	\$ 2,750,976	\$ 14,098,752
Y03	\$ 23,549,131	\$ 9,067,045	\$ 32,616,176
Y04	\$ 34,327,889	\$ 18,724,303	\$ 53,052,192
Y05	\$ 47,352,983	\$ 34,438,533	\$ 81,791,516
Y06	\$ 57,131,632	\$ 53,421,786	\$ 110,553,418
Y07	\$ 63,775,598	\$ 74,925,178	\$ 138,700,777
Y08	\$ 72,186,958	\$ 104,999,212	\$ 177,186,170
Y09	\$ 80,905,725	\$ 144,426,749	\$ 225,332,475
Y10	\$ 92,992,762	\$ 202,893,298	\$ 295,886,060

Note – The values used are illustrative.

3.3 Estimating revenue for transport network projects

As long as transport network projects are strongly related to wholesale telecommunication services, to estimate the net revenue of such projects, it is advisable to use as a reference the public leased line services offer of the incumbent (or the service provider with significant market power).

In cases in which the country in question does not have any public offer related to this kind of wholesale service, one alternative may be to consult the websites of other regulatory authorities in order to arrive at a reliable baseline reference to be used in relation to leased lines and connectivity. This could then be subjected to a purchasing power parity index in order to eliminate any price level difference between currency exchange rates. The prices used as reference must exclude taxes and provision for inflation.

3.4 Revenue behaviour throughout the project

The value of the initial ARPU for the project should reflect the most recently calculated values. The evolution of ARPU over the course of the business plan may be estimated based on a recent ARPU evolution. In cases where ARPU information is not available, it is also possible to source this information from the websites of some telecommunication regulatory authorities of other countries, or of investment banks, using the ARPU of a country with a similar socio-economic profile as an approximation.

Another good strategy is to use the ITU ICT Price Basket (IPB)¹⁷ to estimate net revenue. This comprehensive database provides fixed, mobile and broadband sub-baskets for around 165 countries. It is important to remember to subtract tax effects in the net revenue estimation. When analysing historical trends for ARPU, inflationary effects should also be eliminated from the estimate to ensure the business plan deals in all cases with real values.

After estimating ARPU projections, and already having estimated the projected demand, the projected revenue per year is obtained according to the particular service that will be associated with the network that will be implemented.

Note that in the first year of operation, revenues can be considered only for a six month period, since time needs to be allowed between the deployment of the network and the commercialization of services.

4 Estimating investments in broadband networks (CAPEX)

One of the biggest challenges faced by governments aiming to put in place economically sustainable public policies geared at driving investment in broadband network expansion is to correctly estimate the level of CAPEX needed to fulfil a given country's network infrastructure gaps.

Information on the required level of investment is fundamental to enabling policymakers to elaborate a coherent, credible and reliable plan which can help them evaluate the long-run attractiveness and sustainability of a hypothetical telecommunications operation in unserved geographical regions.

The main inputs for the CAPEX estimation are:

- the forecast demand for mobile and fixed broadband services, as well as detailed information on the current infrastructure gaps – for example, a list of municipalities not served by optical transport networks;

¹⁷ The ICT Price Basket is available at <http://www.itu.int/ITU-D/ict/ipb/>

- the expected demand (in number of users, traffic or in Mbit/s) for mobile and fixed broadband networks for the coming years, by municipality; this information is important both for network design decisions and investment estimation.

Based on these inputs, the CAPEX required to address an identified lack of infrastructure will depend intrinsically on the service and technology chosen. For instance, policymakers aiming to quickly address the lack of broadband offerings in a particular region may choose to model the deployment of cost-effective and rapidly deployed mobile broadband access networks (3G, 4G LTE, etc.), while those planning for the longer term may prefer modelling the deployment of fibre-to-the-home (FTTH) access networks. Even for the deployment of backbone/backhaul transport networks, the choice to model either standard common microwave networks or new generation optical fibre networks depends on the public policy aims and the forecast traffic demand of each municipality or region, and can impact directly on the level of investment required.

In order to provide useful guidance on how to estimate the required CAPEX to address broadband infrastructure needs, and considering the information asymmetry that is inevitable in any policymaker analysis, the following sections of this toolkit will provide examples of trusted approaches that can be followed by governments aiming to foster the deployment of 4G LTE mobile broadband networks, fixed broadband FTTH networks, and broadband microwave and optical fibre transport networks, these being the most common technologies currently chosen for broadband network expansions.

4.1 Mobile broadband access networks

The objective of this model is to estimate the network infrastructure required to meet both the coverage and the capacity demands (Mbit/s) of potential 4G LTE mobile broadband users in municipalities or regions not yet served, in order to evaluate the economic viability of such investments.

To perform this calculation, a modelled operator is proposed, which has only one radio frequency block for use in traditional 4G LTE e-NodeBs (hereinafter referred to as *macrocells*), with a less expensive *small cell* solution better adapted to meeting the increasing demand for data transmission capacity to be implemented in municipalities where capacity demand exceeds the capacity provided by the macrocells.

This simplified small cell solution consists of one sector antenna system and a WiFi hotspot, used for traffic offload directly to the fixed transport network. Figure 6 illustrates the mobile broadband access network topology envisaged.

Figure 6: LTE heterogeneous network



It is interesting to note that the capacity gains from this approach are considerable and reduce the need for future network expansion solely driven by capacity requirements, i.e., operators potentially reduce the need for investment over short periods, better monetizing their infrastructure. Indeed, the solution modelled for the deployment of a hybrid infrastructure of macrocells + small cells + WiFi hotspots is a worldwide trend for 4G LTE wireless broadband heterogeneous networks, driven by

the need to reduce the CAPEX required to meet explosive mobile broadband demand¹⁸. This hybrid strategy offers the threefold advantage of satisfying the need for coverage, supporting user mobility and responding to capacity demand, offering an incremental and better allocated investment over years of operation.

Calculation of investment in coverage site (macrocell) deployment

In order to calculate the number of macrocells required to cover each unserved municipality, the target area to be covered is divided by the maximum area covered by one typical e-NodeB, according to the following equation:

$$N_{macrocells} = \frac{A_t}{A_{eNb_{avg}}}$$

where:

$N_{macrocells}$ is the number of macrocells to be estimated

A_t is the total area, in km², of the target area to be covered

$A_{eNb_{avg}}$ is the maximum area covered by one typical e-NodeB.

For the $A_{eNb_{avg}}$ estimation, the reference can be taken as the average coverage radius of 4G LTE wireless broadband network sites deployed in municipalities already served by 4G LTE networks using the same spectrum. International references obtained from the deployment of 4G LTE wireless broadband networks in other countries can also be used.

Once the number of coverage sites required has been calculated, it is necessary to obtain the unit cost of each site so that it is possible to estimate the required investment. Unit cost can vary significantly between countries, so for accuracy this cost should be obtained from established local mobile broadband operators and local network suppliers.

Finally, a cost-effective 4G deployment must take advantage of passive infrastructure (towers, etc.) available for sharing, since sharing will enable significant cost savings in macrocell deployment.

¹⁸ Source: Cisco Visual Networking Index Global Mobile Data Traffic Forecast Update, 2016-2021: <https://www.cisco.com/c/en/us/solutions/collateral/service-provider/visual-networking-index-vni/mobile-white-paper-c11-520862.html>.

Macrocells

The following example illustrates the estimation of the number of passive and active infrastructure elements needed in the macrocell deployment.

4G Macrocells Estimation

City: Example 1

$A_t = 137 \text{ Km}^2$

$A_{eNb_{avg}} = 7.5 \text{ Km}^2$

$N_{macrocells} = 19$

Passive Infra(towers, etc.) = 19 - 7 = 12

Active Infra (e-NodeBs, etc.) = 19

Towers for sharing = 7 (2G, 3G, etc.)

$$N_{macrocells} = \frac{A_t}{A_{eNb_{avg}}}$$

Source: ITU

Note: The values used are illustrative.

Calculation of investment in small cells and WiFi hotspot deployment

Once the infrastructure needs for coverage sites (macrocells) have been determined, it is time to evaluate the best strategy to address the challenge of building a network that has enough capacity (Mbit/s) to meet 4G LTE wireless network traffic demand with the most optimized CAPEX possible.

The first step is to forecast the expected traffic demand in each municipality for the coming years¹⁹, based on the demand of 4G LTE wireless network users spanning diverse profiles, such as pre-paid or post-paid users of voice and data, modem users who only generate data traffic, etc.

To convert the user demand into the peak traffic capacity required (Mbit/s) in a way that is most useful for network planning, it is necessary to elaborate a matrix of speeds for each user profile, making provision for evolution over the years, given the usual incremental increase in spectral efficiency (bit/s/Hz) of commercial LTE networks.

Based on this methodology, and armed with estimates of 4G LTE wireless network user demand per municipality by type of user profile as well as the estimated matrix of speeds to be offered in 4G LTE wireless network data plans, it is possible to obtain the estimated traffic capacity that needs to be supported by the 4G LTE wireless access network to be deployed in each municipality served.

Once this traffic demand (Mbit/s) is known, and the incremental demand to be served in each year of operation is identified, a calculation can be made of the number of small cells and WiFi hotspots that will need to be deployed each year to meet the demand exceeding the capacity already served by the macrocells. The number of small cells required in each year of service delivery in each municipality can be calculated by using the following equation:

$$N_{small\ cells} = \frac{\max \left\{ \left[D_{T_A} \cdot (1 - F_{off-load}) \cdot F_s \right] - (N_{macrocells} \cdot C_{macrocell}); 0 \right\}}{C_{smallcell}}$$

¹⁹ The number of years depends on the timeframe defined for the NPV calculation. For example, a 10-year demand prediction has been used by Brazil for a fixed broadband project net present value (NPV) calculation.

where:

D_{T_A} is the traffic demand (Mbit/s) of all users of the municipality in a given year A

F_s is the network sharing factor, usually called the *contention ratio*

$C_{macrocell}$ and $C_{smallcell}$ are the capacity (in Mbit/s) provided by each macrocell (traditional e-NodeBs with 3 sectors) or small cell (1 sector only). This capacity is calculated by multiplying the amount of spectrum (MHz) available for 4G LTE networks in the municipality in year A (B_A) the spectral efficiency (bit/s / Hz) of commercial 4G LTE networks in year A (η_A) and the number of sectors per 4G LTE network site (S)

$F_{off-load}$ is the offload factor of 4G LTE network traffic over WiFi networks, that is the percentage of traffic served by a small cell that is offloaded to the WiFi hotspot

Once the equation used to calculate the number of small cells + WiFi hotspots to be installed in each municipality in a given year is presented, we will discuss the assumptions used to define the values of each of the variables that make up the equation.

As mentioned before, D_{T_A} is the demand of year A, i.e., the traffic demand (Mbit/s) existing in year A in a given municipality. The section on small cells below illustrates the application of this formula.

The use of the offload factor $F_{off-load}$ is based on the premise that, given the rapid growth of traffic with the popularization of 4G LTE mobile network terminals, there is a worldwide trend for using WiFi networks to offload some of this traffic²⁰, especially in highly dense urban areas. In addition, the offload factor represents a search for efficiency in network deployment, since certain zones (for example urban micro-centres, malls, airports, etc.) with a high demand concentration may have their capacity largely served by WiFi hotspots.

Recent estimates²¹ indicate that as much as 63 per cent of mobile broadband traffic will flow through WiFi networks, thus reducing the demand requirements that need to be considered in dimensioning a mobile network with licensed frequencies. Furthermore, this premise allows for the optimization of CAPEX in a significant way.

The network sharing factor F_s , also known in the telecommunication ecosystem as the contention ratio, is a parameter commonly considered in the design of packet-switched networks, such as 4G LTE wireless data networks. In network dimensioning equations this parameter is used to provide for the fact that users, in most cases, require network resources (sending and receiving data packets) at different times. Since users are not all drawing on the network mobile capacity at exactly the same time, it would not be efficient for a network to be able to support the total maximum forecast data traffic, since such an occasion would never occur. Instead, the network sharing factor (contention ratio) is used to express the number of users that the network must be capable of supporting simultaneously. This factor may vary for each country and is sometimes established by the national service quality regulatory framework. A typical value considered in broadband network (fixed or mobile) dimensioning is 1:20 (5%), i.e., for each 20 Mbit/s of contracted capacity the network needs to provide only 1 Mbit/s, since in normal conditions only 5 per cent of users will use the network at the same time.²²

The spectral efficiency η_A , in (bit/s / Hz), of commercial LTE networks in year A can be obtained with local operators and network suppliers; generally, 4 bit/s/Hz is the reference point for networks using 256 QAM modulation. Furthermore, forecasts of spectral efficiency evolution can be made by

²⁰ See: <http://docplayer.net/13989507-Smartphone-use-transforming-with-the-rise-of-4g-and-wi-fi.html>. *Smartphone use transforming with the rise of 4G and Wi-Fi*, 2014 Informa UK Ltd

²¹ Source: *Cisco Visual Networking Index Global Mobile Data Traffic Forecast Update, 2016-2021*: <https://www.cisco.com/c/en/us/solutions/collateral/service-provider/visual-networking-index-vni/mobile-white-paper-c11-520862.html>.

²² See: <http://businessdocbox.com/Logistics/66514074-Lte-network-design-from-a-techno-economic-perspective.html>. *LTE Network Design from a Techno-Economic Perspective*:

analysing the historical behaviour of the increasing curve in spectral efficiency of data transmission technologies in mobile networks, from the onset of third generation technologies (WCDMA, HSPA, etc.) until the emergence of LTE networks and subsequent upgrades (*releases*) by the 3GPP Forum. Based on this, an increasing spectral efficiency curve can be projected over the next few years until LTE networks mature and the commercial launch of more advanced mobile network technologies (e.g. 5G).

The final variable is the amount of spectrum (MHz) available for LTE networks B_A in each municipality in a given year A, which will be country-dependent and is a value usually known by regulators.

By understanding all the variables used to calculate the number of small cells required in each year A to meet the data traffic demand in each municipality, it is possible to obtain the quantity of infrastructure to be deployed, not only to address coverage issues but to ensure sufficient capacity to adequately support mobile broadband demand.

Small cells

The following table illustrates the estimation of the number of small cells needed in a given 4G LTE deployment by year, considering the following scenario:

- i) 19 macrocells are needed for coverage;
- ii) the aggregated demand forecast ranges from 100 Gbit/s in the first year to 520 Gbit/s in the tenth year of operation;
- iii) the WiFi off-loading is 67 per cent;
- iv) the contention ratio is 5 per cent;
- v) the spectral efficiency of the 4G LTE network is constant at 3 bit/s/Hz per small cell.

4G Smallcells Estimation											
Capacity to be Served by the Network					Capacity served by Macrocells						
Year	D_{Tc}	$(1 - F_{off-load})$	F_S	$[D_{Tc} \cdot (1 - F_{off-load}) \cdot F_S]$	Year	$N_{macrocells}$	B_A	η_A	S	$C_{macrocell}$	$N_{macrocells} \cdot C_{macrocell}$
1	100 Gbps	37%	5%	1.85 Gbps	1	19	20 MHz	3 bps/Hz	3	0.18 Gbps	3.42 Gbps
2	120 Gbps	37%	5%	2.22 Gbps	2	19	20 MHz	3 bps/Hz	3	0.18 Gbps	3.42 Gbps
3	150 Gbps	37%	5%	2.78 Gbps	3	19	20 MHz	3 bps/Hz	3	0.18 Gbps	3.42 Gbps
4	175 Gbps	37%	5%	3.24 Gbps	4	19	20 MHz	3 bps/Hz	3	0.18 Gbps	3.42 Gbps
5	210 Gbps	37%	5%	3.89 Gbps	5	19	20 MHz	3 bps/Hz	3	0.18 Gbps	3.42 Gbps
6	250 Gbps	37%	5%	4.63 Gbps	6	19	20 MHz	3 bps/Hz	3	0.18 Gbps	3.42 Gbps
7	300 Gbps	37%	5%	5.55 Gbps	7	19	20 MHz	3 bps/Hz	3	0.18 Gbps	3.42 Gbps
8	360 Gbps	37%	5%	6.66 Gbps	8	19	20 MHz	3 bps/Hz	3	0.18 Gbps	3.42 Gbps
9	480 Gbps	37%	5%	7.96 Gbps	9	19	20 MHz	3 bps/Hz	3	0.18 Gbps	3.42 Gbps
10	520 Gbps	37%	5%	9.62 Gbps	10	19	20 MHz	3 bps/Hz	3	0.18 Gbps	3.42 Gbps

Capacity to be Served By Smallcells		Smallcell Capacity				
Year	$\max\{D_{Tc} \cdot (1 - F_{off-load}) \cdot F_S - (N_{macrocells} \cdot C_{macrocell}); 0\}$	Year	B_S	η_A	S	$C_{smallcell}$
1	0	1	20 MHz	3 bps/Hz	1	0.06 Gbps
2	0	2	20 MHz	3 bps/Hz	1	0.06 Gbps
3	0	3	20 MHz	3 bps/Hz	1	0.06 Gbps
4	0	4	20 MHz	3 bps/Hz	1	0.06 Gbps
5	0.47 Gbps	5	20 MHz	3 bps/Hz	1	0.06 Gbps
6	1.21 Gbps	6	20 MHz	3 bps/Hz	1	0.06 Gbps
7	2.13 Gbps	7	20 MHz	3 bps/Hz	1	0.06 Gbps
8	3.24 Gbps	8	20 MHz	3 bps/Hz	1	0.06 Gbps
9	4.54 Gbps	9	20 MHz	3 bps/Hz	1	0.06 Gbps
10	6.2 Gbps	10	20 MHz	3 bps/Hz	1	0.06 Gbps

Number of Smallcells	
Year	$\frac{\max\{D_{Tc} \cdot (1 - F_{off-load}) \cdot F_S - (N_{macrocells} \cdot C_{macrocell}); 0\}}{C_{smallcell}}$
1	0
2	0
3	0
4	0
5	8
6	21
7	36
8	54
9	76
10	104

In this scenario, it would be needed to offer more capacity to the wireless network only in the fifth year. At the end of the project, a total of 104 small cells would be deployed.

Source: ITU

Note: The values used are illustrative.

Infrastructure unit costs

Having defined the number of 4G LTE wireless broadband network sites to be deployed, the next step for CAPEX estimation is to obtain the unit costs involved in deploying each of these sites.

In order to better understand the pricing approach for macrocells, network elements are classified into three categories:

- i) passive infrastructure (towers, etc.), the cost burden of which can be reduced (sometimes very substantially) through the sharing of structures already installed;
- ii) LTE e-NodeBs, which comprise the whole set of equipment that makes up the controller, transmitter and radio system;
- iii) upstream data transport networks, consisting of the transport elements (usually optical) of the LTE site to the operator network. The unit costs of each of these network elements can be obtained from local operators and network suppliers.

Once the prices for the macrocells have been obtained, these values can be used as a reference for estimating the cost of the small cell approach. Market studies²³ have estimated the cost of a typical small cell + WiFi hotspot site as 21 per cent of the macrocell cost. While this percentage serves as a handy guide, current pricing information obtained from local operators and network suppliers should always be used for real planning purposes.

²³ Source: Paolini, M. (2012), *The economics of small cells and Wi-Fi offload*, Senza Fili Consulting, page 2.

Results of the CAPEX estimation

Once the total number of 4G LTE wireless broadband network sites (macrocells and small cells + WiFi hotspots) to be installed each year in each of the municipalities to be served has been estimated, and the unit costs of the access network infrastructure elements have been obtained, the total investment (CAPEX) required by year can be calculated.²⁴

This CAPEX matrix will define the net present value of the 4G LTE wireless broadband network business and will be one of the determining factors in an appraisal of the inclusion of under-served areas in public policy aimed at encouraging the construction of mobile broadband infrastructure.

4.2 Fixed broadband access networks

The modelling used by regulators to estimate the investment necessary to build an FTTH network can be based on internationally recognized references relating to network architecture and techniques for equipment and optical fibre estimation. Once the quantity of equipment and cabling required is calculated and their unit cost determined, the total CAPEX to deploy the network can be obtained.

The first step is the choice of FTTH network technology to be used as reference for network dimensioning. After evaluating the various technologies on the market, GPON (Gigabit Passive Optical Network, ITU-T Recommendation series G.984.1-G.984.6) technology has been chosen for this exercise, owing to the extensive deployment of this technology around the world.

GPON networks, according to Recommendation ITU-T G.984.1²⁵, are characterized by optical line termination systems and optical network terminations, with a passive optical distribution network formed by splitters interconnecting the optical line terminals and the optical network terminals.

For our purposes the most straightforward approach will be to model construction of the network infrastructure using the most conventional topology for FTTH networks, the star topology. Network dimensioning in this exercise thus assumes the existence of a local FTTH central office in each municipality, with optical line terminals and splitters installed according to the desired number of 'homes-passed' in each municipality. Figure 7 illustrates the proposed network topology.

Figure 7: FTTH network topology

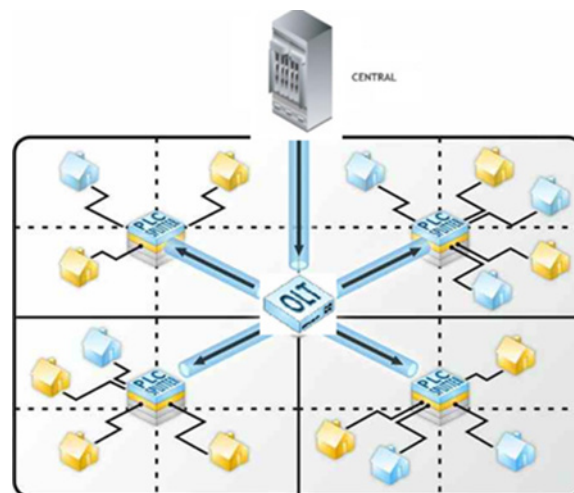

Source: ITU

²⁴ The need for investment in 4G LTE wireless network core equipment was not estimated here since it was assumed that the operation modelled already has 4G LTE operations in the more economic attractive regions of the country and thus already has this equipment.

²⁵ <https://www.itu.int/rec/T-REC-G.984.1/en>

Based on this topology, the next challenge consists of estimating the number of optical line terminals, splitters, optical network terminals, and kilometres of optical fibre cable in the aggregation²⁶ and access²⁷ layers required to implement FTTH and provide ultra-broadband services.

Optical line terminals (OLTs)

For dimensioning the number of OLTs required, it is important to consider Recommendation ITU-T G.984.1 'Gigabit-capable passive optical networks (GPON): General characteristics', which refers to 1:128 as the maximum optical division rate. This means that up to 128 users can be connected to each optical port of an OLT. The decision regarding OLT capacity (in terms of number of ports) is a design choice, since typically 16-port OLTs are readily available on the market. Considering the maximum optical division rate and maximum OLT capacity, it is therefore possible to connect up to 2048 users per OLT. Thus, in general, the number of OLTs needing to be installed in an FTTH network can be calculated as follows:

$$N_{OLT_p} = \frac{N_{hp}}{K_{OLT} \times S_R}$$

where:

N_{OLT_p} is the number of OLTs to be estimated based on the number of ports needed

N_{hp} is the number of homes-passed desired

K_{OLT} is the number of ports of the chosen OLT

S_R is the optical division rate used

However, considering that the typical aggregate traffic flow capacity of an OLT is generally limited to 10 Gbit/s, the larger the number of ports (and, consequently, the number of users connected to the same OLT), the lower the possibility of offering higher speed broadband connections.

For example, an OLT with a maximum number of connected users, an aggregated traffic capacity of 10 Gbit/s and a typical network sharing factor of 5% (1:20) could offer speeds of (approximately) up to 100 Mbit/s to the end user. However, to increase the speed offered beyond this it would be necessary to increase the number of OLTs to meet demand from the same number of users. The equation below presents the formula for calculating the quantity of OLTs given the connection speed offered:

$$N_{OLT_s} = \frac{N_{hp} \times Tx_u \times F_s}{C_{OLT}}$$

where:

N_{OLT_s} is the number of OLTs to be estimated based on the connection speed to be offered to the subscribers

N_{hp} is the number of homes-passed desired

Tx_u is the connection speed offered to a typical FTTH subscriber in Mbit/s

F_s is the network sharing factor

C_{OLT} is the data transmission capacity of an OLT in Mbit/s.

As before, the network sharing factor F_s (contention ratio) in the calculation is a parameter normally considered in the design of packet switched networks such as fixed broadband networks. As outlined

²⁶ The aggregation layer comprises the network between the local FTTH central office and the street-level splitters.

²⁷ The access layer comprises the network between the street-level splitters and subscriber households.

here and in section 6, this element brings into the network dimensioning equation the fact that subscribers do not all access the Internet at the same time, and thus improves efficiency by eliminating the over-provision of capacity. As with the mobile broadband networks discussed above, the typical value for fixed broadband networks is 1:20 ($F_s = 5\%$).

Optical line terminals

Given the two approaches to calculating the number of optical line terminals (OLTs) needed in the FTTH network to be deployed, the first based on the number of physical ports required to connect all homes-passed and the second based on the speed to be offered to the subscribers, the final calculation of the number of OLTs is arrived at by taking the greater number of the two approaches, as illustrated in the following example.

OLTs Estimation	
$N_{OLT_p} = \frac{N_{hp}}{K_{OLT} \cdot S_R}$ <p> $N_{hp} = 50,000$ homes-passed $K_{OLT} = 16$ portas $S_R = 128$ $N_{OLT_p} = 25$ </p>	$N_{OLT_s} = \frac{N_{hp} \cdot Tx_u \cdot F_s}{C_{OLT}}$ <p> $N_{hp} = 50,000$ homes-passed $Tx_u = 80$ Mbit/s $F_s = 5\%$ $C_{OLT} = 10,000$ Mbit/s $N_{OLT_s} = 20$ </p>
$N_{OLT} = \max(N_{OLT_p}; N_{OLT_s}) = 25$	

Source: ITU

Note: The values used are illustrative.

Splitters

Dimensioning the quantity of splitters to be installed in each municipality to cover the desired number of homes-passed is to a large extent a design choice, and depends on the characteristics of the urban area to be served and expected user demand. Considering the need to connect up to 128 users per port of a typical OLT, several splitter configurations can be chosen, for example 1:2, 1:4, 1:8, 1:16, etc. If we consider the deployment of only one layer of 1:16 splitters, eight splitters would be required to connect each OLT port to 128 users. In general, the formula for calculating the number of splitters required in a network with only one layer of splitters is:

$$N_{splitter} = \frac{N_{hp}}{K_{splitter}}$$

where:

$N_{splitter}$ is the number of splitters required across the network

N_{hp} is the number of homes-passed desired

$K_{splitter}$ is the number of ports available according to the type of splitter chosen, i.e., the maximum number of users per splitter.

Optical fibre calculation (splitter layer)

The following example illustrates the estimation of the number of splitters needed in a given FTTH deployment.

Splitters Estimation

$$N_{splitter} = \frac{N_{hp}}{K_{splitter}}$$

$$N_{hp} = 50,000 \text{ homes-passed}$$

$$K_{splitter} = 16 \text{ portas}$$

$$N_{splitter} = 3,125 \text{ splitters}$$

Source: ITU

Note: The values used are illustrative.

Mathematical modelling for optical fibre cable dimensioning

Once the number of splitters and OLTs required to meet the desired number of homes-passed has been calculated, the next step in modelling the investment required is the calculation of the number of kilometres of optical fibre needed to interconnect all elements in the star hierarchy to the FTTH central office. After evaluating the most-used methodologies for estimating fibre mileage required to implement FTTH networks, two approaches – spatial and geometric – stand out.

The **spatial approach** is based on the existence of geospatial data for the urban area to be served, with information on the distribution profile of households, road networks, geolocation of existing telecommunication elements, and so on. Based on this detailed information, the geographic position of the local FTTH central office, splitters and OLTs is defined in the optimal way to accommodate the desired number of homes-passed while minimizing the number of kilometres of cable necessary to interconnect the required equipment. Although accurate, the disadvantage of this model is precisely the need for comprehensive geospatial information that, in most cases, is simply not available.

Alternatively, the **geometric approach** uses mathematical models to calculate the amount of optical fibre required based on simplifications of the geospatial conditions, geographical relief, road networks and house distribution. Although less accurate than the spatial approach, it can provide a good estimate the amount of fibre needed even in the absence of geospatial information, and represents a quick and reasonably accurate means of network dimensioning.

*Geometric versus Geographic Models for the Estimation of an FTTH Deployment*²⁸ offers a comparative analysis of a spatial calculation model and two geometric calculation models, the Triangle Model (TM) and the Simplified Street Length Model (SSL). The result of this comparative analysis demonstrates that the SSL geometric model provides more accurate results than the triangle model, but is nonetheless substantially less accurate than the spatial model. In addition, it is suggested that the main sources of inaccuracy between geometric models and the spatial model are largely due to not-captured imperfections in geographical relief and the spatial distribution of houses. Correction factors to be applied to the geometric model results are proposed in order to improve accuracy.

²⁸ An academic paper published by the IEEE in 2013: <https://biblio.ugent.be/publication/4402261>

In light of this, in cases where unavailability of geospatial data for the municipalities to be served precludes the use of the spatial model it is suggested the use of the corrected SSL geometric model outlined in the paper cited for calculating of the amount of optical fibre cable needed to interconnect the various optical network elements.

The SSL model adopts as a basic premise a uniform distribution of the elements to be connected by optical fibre in a square-shaped area, where the upper layer element, to which all the others interconnect, is located in the centre of this square, as presented in the schema in Figure 8.

Figure 8: SSL geometric model

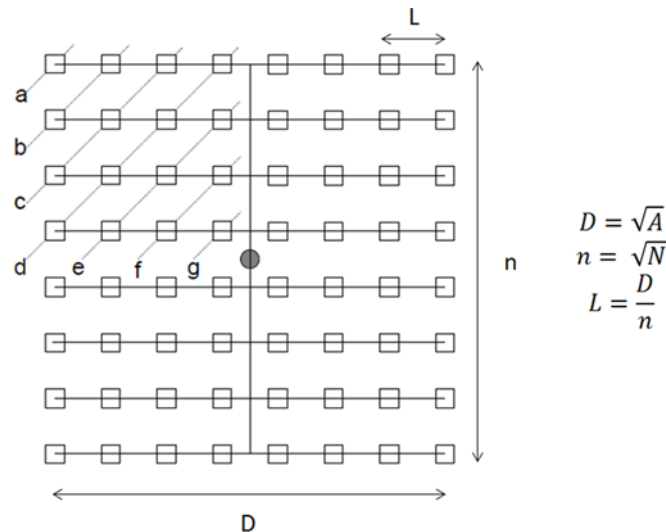

Source: ITU

where:

A is the square area in km^2

D is the length in kilometres of one side of the square

L is the distance in kilometres between each element

N is the number of elements included in the square

n is the number of elements placed on one side of the square.

In this scenario, considering the common restriction of laying optical fibre along existing streets and paths (arranged in the SSL model in horizontal and vertical lines), the challenge lies in calculating the distance from each element to the centre of the square, this distance being intrinsically dependent on the distance between the elements uniformly distributed and the quantity of those elements in the square. In addition, another factor that should be considered in the calculation is the existence of two or more elements stacked in the same position. This effect is captured by the variable K , which is the average number of elements in the same position in the considered square.

An important point to be observed in this geometric representation is that if we divide the considered square into four quadrants of equal size and categorize each the elements belonging to the same diagonal of a quadrant, all elements of the same category will be the same distance from the centre of the original square. For example, if we sort the elements into categories from a to g , as in Figure 8 above, the distance of each element to the centre of the square will be $a = (n-1) \cdot L$; $b = (n-2) \cdot L$; $c = (n-3) \cdot L$; ...; $g = L$.

In this way, multiplying the distance of a typical element from each category by the number of elements in the category will give the total distance of all elements of each category to the centre

of the larger square. By adding the total distances of all categories the total added distance of all elements of a quadrant to the centre of the larger square will be obtained. From there to calculating the total distance of all elements contained in the square, it is enough to multiply by four the added distance of a quadrant (since there are four quadrants) and finally multiply this value by the factor K , since each element must have an optical fibre interconnecting it to the centre of the square, even if it is stacked on another element.

The formula below summarizes the calculation of the amount of optical fibre (L_{fo}) required to interconnect all elements to the centre of the square.

$$L_{fo} = 4xKxLx \sum_{i=1}^{n-1} [\min(i, n-i) x (n-i)]$$

From here, the next step is to define the values of the variables K , L and n for each municipality and for each network layer, which will be discussed shortly.

Optical fibre calculation

In order to calculate the number of kilometres of optical fibre using the SSL geometric model, it is necessary to define the network elements and values of the model variables A , D , L , N , n and K . Considering that we have a local FTTH central office, OLTs, splitters and residences to be connected by fibre in each municipality, we need to perform this calculation through a series of steps.

In the first step, the amount of fibre required to connect the OLTs of each municipality to the local FTTH central office is calculated. For this step, the value of the urban area to be covered is assigned to variable A , and the number of OLTs to be installed is assigned to the variable N . From these two variables the values of n , D and L are calculated, and considering $K = 1$ (uniform distribution of OLTs throughout the urban area covered), the amount of fibre needed to interconnect all OLTs to the local FTTH central office using the SSL geometric model formula can be estimated.

Once the number of kilometres of optical fibre cable needed to connect the OLTs to the local FTTH central office in each municipality has been calculated using the SSL model, the result is then divided by the aforementioned correction factor of 55.5 per cent to compensate for any underestimation resulting from the SSL geometric model.

In the second step the number of fibre kilometres required to connect the first layer splitters to the OLTs is calculated. For this, the calculation is performed for each OLT and its splitters, and the result then multiplied by the quantity of OLTs to be installed.

In this second step, the value of the same urban area considered in the first step is assigned to variable A , but divided by the number of OLTs in order to apply to the urban area corresponding to just one OLT. The number of splitters per OLT to be installed is assigned to variable N . From these two variables we derive the values of n , D and L , and also considering $K = 1$ (uniform distribution of splitters across the urban area of one OLT), the amount of fibre needed to interconnect all splitters to their corresponding OLT is estimated by applying the SSL model equation and the same 55.5 per cent correction factor over its result. If more than one layer of splitters is foreseen between OLTs and subscribers, the same calculation is repeated for the other layers of modelled splitters.

Finally, the number of kilometres of fibre required to connect subscribers to the splitters in each municipality must be calculated. To do this, the calculation is performed for a single splitter and its respective subscribers, and the results then multiplied by the number of splitters to be installed.

The value of the same urban area considered in the first step, but divided by the number of splitters to be installed, is assigned to variable A . The number of homes-passed per splitter is assigned to variable N . From these two variables, the values of n , D and L can be derived, and considering $K = 1$ (uniform

distribution²⁹ of residences throughout the urban area covered by each splitter) the amount of fibre needed to interconnect all homes-passed to their respective splitter can be calculated by applying the SSL model equation and dividing its result by a correction factor, this time of 67 per cent³⁰, in order to correct the underestimation resulting from the use of the simplified geometric model.

So far, so good. However, not all available homes-passed will be converted into homes-connected. The number of homes-connected should therefore vary between 0 and the number of homes-passed available, with only the homes-connected counted in the optical fibre calculation. In order to factor this in, bearing in mind that it is not known which homes-passed will subsequently be converted to homes-connected (for example, those closest to or furthest from the splitter), a fair approximation would be to calculate the average number of kilometres of fibre to interconnect one home-passed to its respective splitter in each municipality, and multiply this value by the total of new homes-connected estimated year-on-year. This calculation will reveal the total amount of optical fibre cable needed to connect all homes-connected each year in each municipality.

An important point that should also be considered in calculating the total number of homes-connected is the effect of *churn* on the subscriber base. Churn is the measure of an operator subscriber base replacement; in practice, the churn rate represents the percentage of customers who cancel their subscription to a particular service in a given period.

As a result of the churn effect the number of new installations carried out each year is higher than the net change in an operator subscriber base. That is, if a given operator has a base of 1 000 subscribers and this base grows to 1 100 in the following year, the effect of churn means that the number of new services contracted in this period is *more than 100*. The explanation is simple: if churn has been measured at 5 per cent in that year, then of the 1 000 initial subscribers, 50 will have cancelled their contracts while 150 new subscribers will have contracted the service, to bring the new subscriber base total to 1 100.

This effect of gradual renewal of the subscriber base severely impacts the CAPEX of a FTTH network project. In each year, the need to install the net change in demand plus the percentage of *churn* multiplied by the total subscribers at the end of the previous year must be considered. This means a need for more optical fibre cable and more CPE packages, which include the end-user router (CPE) and the optical network terminal (ONT) to be installed in subscriber homes. Of course, the majority of CPEs and ONTs previously installed in the homes of subscribers who cancelled their contracts can and should, if possible, be reused in the homes of new subscribers – with the percentage of reuse dependent on logistical storage and transport issues.

The equations for calculating the number of kilometers of optical fibre cable needed to interconnect homes-connected to their respective splitters, as well as for calculating the number of required CPE packages, are presented below:

$$Fiber_HC_{total_t} = Fiber_HC_{avg} \cdot [N_{hct} - N_{hct-1} \cdot (1 - churn)]$$

$$N_{Pct_CPE_t} = N_{hct} - N_{hct-1} [1 - churn \cdot (1 - F_r)]$$

where:

$Fiber_HC_{total_t}$ is the total optical fibre (in km) to be installed in a given year t to connect homes-connected to their respective splitters

²⁹ This simplification is used due to the usual unavailability of information of home verticalization level.

³⁰ Average % of underestimation in the access layer in dense areas; see 'Geometric versus geographic models for the estimation of an FTTH deployment', Telecommunication Systems Volume 54, page 21.

$Fiber_{-}HC_{avg}$ is the average total optical fibre cable (in km) needed to connect one home-passed to its respective splitter

N_{hct} is the number of subscribers (homes-connected) in a given year t

N_{hct-1} is the number of subscribers (homes-connected) in a given year $t-1$

$churn$ is the percentage of subscribers present in year $t-1$ who left the subscriber base in year t ;

$N_{Pct_CPE_t}$ is the number of CPE packages to be installed in a given year t ;

F_r is the percentage of reuse of ONTs withdrawn from the homes of subscribers who cancelled their subscription in year t .

Note that churn and percentage reuse rates for CPEs and ONTs can vary significantly between countries, so it is highly advisable that regulators obtain accurate figures from local operators. However, where it proves impossible to obtain such information, a churn rate of 5 per cent per year and a reuse factor of 80 per cent are generally considered reasonable for network dimensioning.

Optical fibre calculation (homes passed)

First step:

Optical Fibre Calculation - OLTs Layer		
$A = 100 \text{ km}^2$	$K = 1$	$L_{fo} = 4 \cdot K \cdot L \cdot \sum_{i=1}^{n-1} [\min(i, n-i) \cdot (n-i)]$
$N = 25 \text{ OLTs}$	$n = \sqrt{N} = 5$	$L_{fo} = 4 \cdot 1 \cdot 2 \cdot \sum_{i=1}^4 [\min(i, 5-i) \cdot (5-i)]$
$D = \sqrt{A} = 10 \text{ km}$	$L = \frac{D}{n} = 2 \text{ km}$	$L_{fo} = 4 \cdot 1 \cdot 2 \cdot [(1 \cdot 4) + (2 \cdot 3) + (2 \cdot 3) + (1 \cdot 1)]$
		$L_{fo} = 136 \text{ km}$
		$L_{fo_corrected} = \frac{136}{0.555} \cong 245 \text{ km}$

Second step considering one layer of splitters:

Optical Fibre Calculation - Splitters Layer

$$A = \frac{100 \text{ km}^2}{25 \text{ OLTs}} = 4 \text{ km}^2/\text{OLT}$$

$$N = \frac{3,125 \text{ Splitters}}{25 \text{ OLTs}} = 125 \text{ Splitters/OLT}$$

$$n = \sqrt{N} \cong 11 \quad K = 1$$

$$D = \sqrt{A} = 2 \text{ km} \quad L = \frac{D}{n} \cong 0.18 \text{ km}$$

$$L_{fo} = 4 \cdot K \cdot L \cdot \sum_{i=1}^{n-1} [\min(i, n-i) \cdot (n-i)]$$

$$L_{fo} = 4 \cdot 1 \cdot 0.18 \cdot \sum_{i=1}^{10} [\min(i, 11-i) \cdot (11-i)]$$

$$L_{fo} = 4 \cdot 1 \cdot 0.18 \cdot [10 + 18 + 24 + 28 + 30 + 25]$$

$$L_{fo} = 118.8 \text{ km per OLT}$$

$$L_{fo_corrected} = \frac{118.8}{0.555} \cong 214 \text{ km per OLT}$$

The calculation of the total optical fibre (in kilometres) to be installed in a given year $t=1$ to connect homes-connected to their respective splitters as well as the total number of CPE packages to be installed in the same year in a given city.

Optical Fibre Calculation - Homes-Passed (HP) Layer

$$A = \frac{4 \text{ km}^2/\text{OLT}}{125 \text{ Splitters/OLTs}} = 0,032 \text{ km}^2/\text{Splitter}$$

$$N = \frac{50,000 \text{ HP}}{3,125 \text{ Splitters}} = 16 \text{ HP/Splitter}$$

$$n = \sqrt{N} \cong 4 \quad K = 1$$

$$D = \sqrt{A} \cong 0.18 \text{ km} \quad L = \frac{D}{n} \cong 0.045 \text{ km}$$

$$L_{fo} = 4 \cdot K \cdot L \cdot \sum_{i=1}^{n-1} [\min(i, n-i) \cdot (n-i)]$$

$$L_{fo} = 4 \cdot 1 \cdot 0.045 \cdot \sum_{i=1}^3 [\min(i, 4-i) \cdot (4-i)]$$

$$L_{fo} = 4 \cdot 1 \cdot 0.045 \cdot [(1 \cdot 3) + (2 \cdot 2) + (1 \cdot 1)]$$

$$L_{fo} = 1.44 \text{ km per Splitter}$$

$$L_{fo_corrected} = \frac{1.44}{0.67} \cong 2.15 \text{ km per Splitter}$$

$$Fiber_HC_{avg} = \frac{2.15 \text{ km/Splitter}}{16 \text{ HP/Splitter}} = 0.135 \text{ km/HP}$$

Considering:

$$N_{hc_1} = 10,000 \quad N_{hc_0} = 1,000 \quad \text{churn} = 5\% \quad F_r = 80\%$$

and:

$$Fiber_HC_{total,t} = Fiber_HC_{avg} \cdot [N_{hc_t} - N_{hc_{t-1}} \cdot (1 - \text{churn})]$$

$$N_{Pct_CPE,t} = N_{hc_t} - N_{hc_{t-1}} \cdot [1 - \text{churn} \cdot (1 - F_r)]$$

We have:

$$Fiber_HC_{total,1} = 0.135 \cdot (10,000 - 1,000 \cdot (1 - 0.05)) = 0.135 \cdot 9,050 \cong 1,222 \text{ km}$$

$$N_{Pct_CPE,1} = 10,000 - 1,000 \cdot [1 - 0.05 \cdot (1 - 0.8)] = 10,000 - 990 = 9,010 \text{ Pct_CPE}$$

Source: ITU

Note: The values used are illustrative.

FTTH network unit costs

The FTTH network model presented so far consists of local FTTH central offices routing local traffic to the operator backbone, OLTs, splitters and finally optical fibre cables and CPE packages. It is worth noting that smaller capacity (lower cost) optical fibre cable can be used for connecting splitters

and homes-connected, while greater capacity (more expensive) optical fibre can be reserved for interconnecting splitters, OLTs and the local FTTH central office.

As before, the unit costs of each of these network elements network should be obtained directly from local operators and network suppliers.

Results of the CAPEX estimation

Once the number of local FTTH central offices, OLTs, splitters, CPE packages and kilometres of optical fibre required for FTTH network deployment in each of the municipalities has been calculated, as well as the unit costs of this equipment, the total investment (CAPEX) required by year can be obtained.³¹

It is important to emphasize at this point that the impact of the investment estimate on the cash flow of the modelled operation will depend on the term defined for the installation of the infrastructure – usually the first years of operation. For subsequent years there will be only CAPEX related to the laying of optical fibre cables needed to interconnect new subscribers to splitters and the cost of CPE package acquisition and distribution to subscribers – infrastructure needs that will vary according to the evolution of FTTH subscriber demand over the years.

4.3 Transport networks

In light of increasing demand for ultra-broadband access networks, many countries are suffering a lack of transport network infrastructure capable of routing all inbound and outbound data traffic between municipalities or regions and the operator backbone network.

Policymakers now often face the challenge of boosting optical transport network deployment through public policies that offer favourable conditions to attract private investment to bridge this infrastructure gap. In this context, a CAPEX estimation of the deployment of optical fibre transport networks is frequently useful for developing or evaluating economically sustainable infrastructure deployment projects.

In order to simplify the project and CAPEX estimation, for the purposes of this exercise an optical fibre transport network can be considered as a set of optical fibre links with Synchronous Digital Hierarchy (SDH) transmitters and amplifiers at their endpoints, connected by buried optical fibre cables, with some fibre repeaters placed along the cables. In addition, network elements like dense wavelength division multiplexing-based reconfigurable optical add-drop multiplexers (DWDM ROADMs) and optical distribution frames (ODFs) are required to integrate data traffic into the national backbone network.

Both the number of network elements needed and their required capacity are strongly dependent on the minimum throughput required (municipality or regional aggregate traffic demand) and the distance between the municipality or region and the nearest operator backbone drop. When these two pieces of vital information are known for all transport links needed, the total CAPEX can be estimated.

In the case of endpoint network equipment – specifically, transmitters – the number of elements needed is based on the demand of each municipality. That is, the use of equipment with a specific data transmission capacity (Mbit/s) is considered and, based on the data demand, the necessary quantity of equipment is estimated.

The backbone equipment, however, represents possible network adjustments needed to support the demand of a particular municipality. Indeed, connecting a new municipality to the backbone may require expansion of the capacity of some network elements. In this case, for each municipality is necessary to do the quantification of the backbone network elements improvement.

³¹ The CAPEX needed to route data traffic out of the municipalities (upstream of the local exchange FTTH Centre) was not considered, on the assumption of a pre-existing national backbone network interconnecting all the municipalities to be included in the FTTH project.

The last group of network elements is related to the total network length. In an optical fibre network the amount of fibre and number of ducts and trenches needed depends directly on the network length, with repeaters inserted at given distances, depending on their range. The range of fibre repeaters varies depending on network supplier and may also be expected to evolve over time; however, as a general rule the inclusion of repeaters every 70 km is fairly standard for optical fibre transport network designs.

To calculate the cost of this set of network elements, it is necessary to define the length of each network link to be constructed. This can be done using, as a reference, the lowest road distance between the municipality that is to be connected and the national optical fibre backbone, since laying fibre along inter-municipal highways and roads usually reduces costs and deployment time.

Note that this calculation strategy is based on deployment of the network in a star topology (point-to-point connection without optimization). However, since more than one municipality can be connected to the same point on the national backbone network, the possibility of implementing parts of the network in a ring topology, in which municipalities are connected to each other and have a common point of traffic flow to the national backbone, should be evaluated. This hybrid approach significantly reduces the number of kilometres of fibre needed, but does require regulators to first define the physical topology of the network to be deployed.

Finally, having calculated the volume of equipment and optical fibre cable needed, the result is multiplied by the unit cost of such equipment, obtained preferably directly from manufacturers and providers already operating in the country concerned. The final result of all these calculations yields the total CAPEX project estimation.

5 Estimating operational expenses (OPEX) for broadband service provision

This section deals with estimating the costs and current expenses (OPEX) of a broadband project in order to accurately estimate cash flows for the elaboration of the business plan. We will consider three main approaches for estimating OPEX:

- using cost models;
- using past costs and expenses;
- using benchmarks.

For policymakers, the decision as to which to adopt will depend on data availability.

5.1 Using cost models to estimate OPEX

The projection of the value of expenses when calculating project NPV can be derived from information extracted from the cost model for cases in which telecoms regulatory bodies have, as a regulatory obligation, accounting separation and presentation of cost models for the purpose of regulating wholesale tariffs.

Although such regulatory obligations are related to estimating the costs of wholesale products, the data associated with such cost accounting provides valuable inputs that can be used to estimate OPEX for broadband projects.

An interesting method is the use of fully allocated costs (FAC) data, a top-down approach³² to estimating the operational costs associated with the provision of broadband services. In this approach, the total cost of a service offered by the operator comprises all accounting costs incurred by the company in providing that service – including capital costs. The total cost of a product can thus be represented by the following equations:

$$\text{Total cost of product (TC)} = \text{expenses} + \text{cost of capital}$$

$$\text{Cost of capital (CC)} = \text{capital employed in the product} \times \text{WACC}$$

where:

Expenses refers to the sum of the cost of service, sales, general and administrative expenses and financial expenses associated directly or indirectly with the production of the product;

Cost of capital (CC) is the hypothetical remuneration that the provider should obtain for maintaining the capital invested in its assets;

WACC is the weighted average cost of capital.

Figure 9: Total costs composition

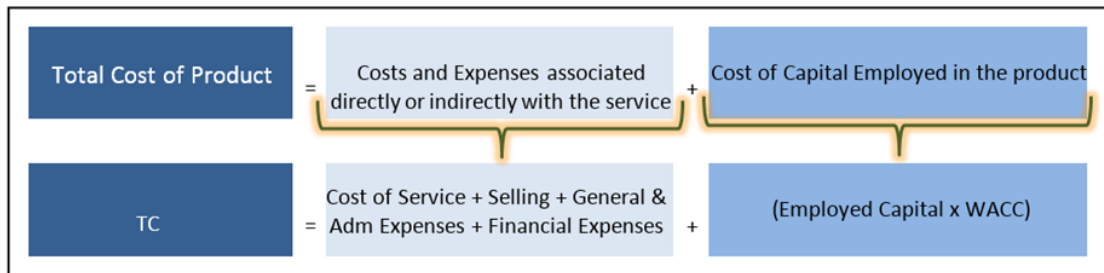

Source: ITU

It should also be noted that various telecommunications services offered by operators themselves use other services that are produced internally, so the total cost of product must cover expenses related to such internal transfers, if they exist.

Internal transfers can be valued in two ways:

- i) if the product has external commercialization, the internal transfer price must be the same as the price charged to other telecommunication service providers;
- ii) if there is no external commercialization, the internal transfer price is based on the total cost of product, calculated by the equation (Figure 9) on total cost of product (TC).

Based on information presented by the providers in their accounting separation provisions and methodology developed by the regulatory agency under the top-down cost model, we can determine the composition of the total cost of each of the services offered.

The projection of OPEX needed to calculate the broadband project NPV can be based on the quotient of the sum of expenses incurred in the provision of a set of services offered by a provider or group of providers, and the sum of the net operating revenue of this same set of services.

³² In such an approach, the calculation starts from the actual accounting information of the operators and is allocated to each services in a specific way.

Figure 10: Expenses/net revenue ratio



Source: ITU

The resulting ratio of total costs and expenses / net revenue should be applied to revenues estimated year by year in the business plan, resulting in the estimation of part of the OPEX.

When analysing the group of expenditure allocations that comprise the ‘costs of services’ category, it is possible to classify these (based on their characteristics) into two distinct subcategories: (a) operation and maintenance costs; and (b) compensation paid to other lenders (e.g., interconnection, network rental and other such expenses).

At this point it only remains to estimate the portion of expenditure related to operation and maintenance costs (OPEX and operation and maintenance) that was excluded from costs of service calculations because of being intrinsically dependent on the CAPEX of the project. To estimate this portion of the OPEX, annual unit OPEX information can be used for each of the network elements required for the construction of the network.

Table 3: Operation and maintenance costs

Network Elements	CAPEX	OPEX
Element 1	X	% of X
Element 2	Z	% of Z
Element 3	Y	% of Y
...
		O&M OPEX

Since the calculations for operation and maintenance costs is strictly related to the CAPEX that will be implemented, the costs related to this subcategory of expenses can be calculated using a percentage of the CAPEX projection methodology, instead of using averages derived from the historical data of the service provider.

Table 4: Total OPEX

	Year 1	Year 2	Year 3	Year 4	...
Net Revenue	X	Z	Y	W	...
Exp/Rev Ratio	r%	r%	r%	r%	r%
OpeX 1	X . r%	Z . r%	Y . r%	X . r%	...
O&M Opex	O&M Opex	O&M Opex	O&M Opex	O&M Opex	
Total Opex	(X . r%) + O&M Opex	(Z . r%) + O&M Opex	(Y . r%) + O&M Opex	(Y . r%) + O&M Opex	

Using cost models to estimate OPEX

TOTAL COSTS AND REVENUE OF ADDITIONAL MOBILE SERVICES						
Operating Revenue		255,432,605				
Costs and Expenses + Cost of Capital Employed		127,568,537				
Cost of services		43,845,976				
Commercial expenses		51,119,948				
Administrative and general expenses		32,602,613				
(Expenses / Revenue) Ratio			0.50			
	TOTAL REVENUE	(Expenses/ Revenue) Ratio	OPEX 1	VOLUME	OPEX 2 TOTAL	TOTAL OPEX
Y01	\$ 3,774,600	0.50	\$ 1,885,116	100	\$ 2,249,750	\$ 4,134,866
Y02	\$ 14,098,752	0.50	\$ 7,041,220	200	\$ 4,499,500	\$ 11,540,720
Y03	\$ 32,616,176	0.50	\$ 16,289,220	300	\$ 6,749,250	\$ 23,038,470
Y04	\$ 53,052,192	0.50	\$ 26,485,406	400	\$ 8,999,000	\$ 35,484,406
Y05	\$ 81,791,516	0.50	\$ 40,848,442	500	\$ 11,248,750	\$ 52,097,192
Network Elements	CAPEX	% OPEX	OPEX 2 UNIT			
Element 1	\$ 23,750	11%	\$ 2,613			
Element 2	\$ 222,500	7%	\$ 15,575			
Element 3	\$ 142,500	3%	\$ 4,275			
Element 4	\$ 3,500	1%	\$ 35			
	Total		\$ 22,498			

Scenario: A mobile operator that will launch a 4G LTE wireless broadband network project. In order to estimate the OPEX of the new project, one of the possible approaches is using cost models already developed/applied by the regulator for other mobile services.

Source: ITU
 Note: The values used are illustrative.

5.2 Using past costs and expenses to estimate OPEX

In the absence of a cost model mature enough to estimate OPEX for the product that will be launched, an alternative may be using the balance sheet data of companies already established in the country that have been delivering an equivalent service (or very similar) to the one proposed in the business plan.

The recommended approach is to evaluate a historical trend of how operating expenses have behaved as a function of net revenue. Once a stable relationship between these two variables has been identified, this ratio can be used to estimate OPEX.

Figure 11: Historical expenses / net revenue ratio



Source: ITU

When it is not possible to identify a stable relationship between revenues and expenses, the best strategy is to review the analytical accounts and remove possible biases, so that a stable estimation can be used throughout for cash flow.

After estimating the ratio between operational expenses (including cost of service, sales, general and administrative expenses) and net revenue, this ratio should be applied to the total annual revenue estimated in the cash flow. The result gives the OPEX for each year.

Table 5: Total OPEX

	Year 1	Year 2	Year 3	Year 4	...
Net Revenue	X	Z	Y	W	...
Exp/Rev Ratio	r%	r%	r%	r%	r%
Total Opex	X . r%	Z . r%	Y . r%	X . r%	...

Source: ITU

5.3 Using benchmarks to estimate OPEX

When a service is relatively new and there are no sufficiently mature commercial operations in the country in question that would make it possible to estimate OPEX based on real balance sheet data, using benchmarks offers a reasonable alternative.

Reference points for modelling total expenses of a business plan can be readily found in specialized literature, including evaluating the behaviour of a company offering an innovative (and perhaps previously untried) service. One of the most widespread benchmarks pertains to the relation between CAPEX and OPEX through the ratio CAPEX/TCO³³ for projects involving new technologies. At least three different market references should be selected, and from these a benchmark value can be defined to be applied in the business plan.

Through this approach, the total OPEX estimate is made based on a direct relationship with total CAPEX, as shown in Figure 12.

Figure 12: CAPEX / OPEX ratio



Source: ITU

However, since current costs and expenses generally have a strong relation to the number of active users in the network, to estimate annual OPEX we suggest dividing total OPEX – estimated as a function of total CAPEX – by the sum of users in each year of the business plan, then multiplying this figure by the total number of users expected each year, thus establishing an annual evolution of OPEX according to user demand.

³³ TCO (total cost of ownership) = CAPEX + OPEX

Figure 13: Unit OPEX



Source: ITU

Table 6: Total OPEX

	Year 1	Year 2	...	Year n	TOTAL
Demand	X	Z	...	W	Total Demand
Unit Opex	u	u	u	u	u
Opex	X . u	Z . u	Y . u	X . u	Total Opex

Source: ITU

Using past costs and expenses to estimate OPEX

Scenario: A fixed broadband operator which will launch a FTTH project in a country alongside other operators that already provide that service. In order to estimate the OPEX of the new project, one of the possible approaches is using the balance sheet data of operator companies already established in the country that have been delivering an equivalent (or very similar) service to the one that will be launched.

This example shows an illustrative balance sheet of an already established operator. To estimate the expenses/revenue ratio it is necessary to eliminate depreciation and amortization costs, since the ratio will be calculated directly from CAPEX. The estimated ratio will be applied to the estimated revenue in order to estimate OPEX

Scenario: a mobile operator that will launch a 4G network project. In order to estimate the OPEX of the new project, one of the possible approaches is using cost models already developed/applied by the regulator for other mobile services.

TOTAL COSTS AND REVENUE OF ADDITIONAL MOBILE SERVICES

Operating Revenue	255,432,605
Costs and Expenses + Cost of Capital Employed	127,568,537
Cost of services	43,645,976
Commercial expenses	51,119,948
Administrative and general expenses	32,602,613

(Expenses / Revenue) Ratio 0.50

	TOTAL REVENUE	(Expenses/ Revenue) Ratio	OPEX 1	VOLUME	OPEX 2 TOTAL	TOTAL OPEX
Y01	\$ 3,774,600	0.50	\$ 1,885,116	100	\$ 2,249,750	\$ 4,134,866
Y02	\$ 14,098,752	0.50	\$ 7,041,220	200	\$ 4,489,500	\$ 11,540,720
Y03	\$ 32,616,176	0.50	\$ 16,289,220	300	\$ 6,749,250	\$ 23,038,470
Y04	\$ 53,052,192	0.50	\$ 26,485,406	400	\$ 8,999,000	\$ 35,484,406
Y05	\$ 81,791,516	0.50	\$ 40,848,442	500	\$ 11,248,750	\$ 52,097,192

Network Elements	CAPEX	% OPEX	OPEX 2 UNIT
Element 1	\$ 23,750	11%	\$ 2,613
Element 2	\$ 222,500	7%	\$ 15,575
Element 3	\$ 142,500	3%	\$ 4,275
Element 4	\$ 3,500	1%	\$ 35
Total			\$ 22,498

Source: ITU

Note: The values used are illustrative.

6 Estimating weighted average capital cost (WACC)

Determining WACC is a critical step in the price-setting process for the telecommunications sector and has a major influence on telecommunication auction models and spectrum pricing models. If WACC is set too low, it can discourage new investments and result in prices that are below efficient costs. On the other hand, if it is set too high, it can encourage over-investment and result in prices that are too high.

Broadly, WACC is the percentage rate equivalent to the weighted average of the opportunity costs of the sources of permanent financing of providers. The parameters of these calculations are provided by a formula derived from the capital asset pricing model (CAPM), defined as:

$$WACC_J^{After Tax} = K_d (1 - \tau) (D|D + E) + K_e^j (E|D + E)$$

where:

K_d is the cost of debt

τ is the tax rate

$(D|D + E)$ is the percentage of capital that is debt

K_e^j is the cost of equity

$(E|D + E)$ is the percentage of capital that is equity

Note that in some countries the actual indebtedness of telecommunication service providers can vary widely, especially between national providers and those with overseas headquarters which are able to benefit from capitalizations outside the group and from intra-group financing.

Given this wide range of potential indebtedness, a regulatory authority may choose to set the level of indebtedness based on the average level of debt adopted by investment banks, regulators around the world and the average of global companies.

Cost of debt estimation

The cost of debt is estimated according to the equation:

$$K_d = rd_f^T (1 + Spread)$$

where:

rd_f^T is the risk-free bond

$Spread$ is the credit risk rate, taken as the average spread paid by all telecommunications providers in that market

The cost of equity estimation

The cost of equity is estimated according to the equation:

$$K_e^j = (re_f^T + \beta_j MRP + CRP) \times ((1 + \pi_{local}) | (1 + \pi_{US}))$$

where:

re_f^T is the risk-free rate, based on the general concept of returns on a bond based on assets with a yield to maturity of at least five years

β_j is the equity beta. It is possible to calculate this according to the telecommunication provider share price against the stock market as a whole, or instead to use an international benchmark. Either approach should use an unlevered beta which will be levered by the optimal capital structure defined according to the capital structure of the local telecommunications operators

CRP is the Country Risk Premium

When the cost of equity is estimated according to the global approach it is necessary to insert in the K_e^j equation the CRP and the difference between local inflation and that of the United States of America

MRP is the market risk premium.

The market risk premium estimation (MRP)

The market risk premium is estimated according to the equation:

$$MRP = \frac{1}{P} \sum_{h=1}^p (r_m^{T-h} - re_f^{T-h})$$

where:

r_e^{T-h} is the risk-free rate

r_m^{T-h} is the return of the market index

The historical data timescale used to estimate the market risk premium should not be less than five years. Moreover, periods that reflect situations of abnormality in the market should be disregarded.

Local CAPM or global CAPM

There are two main approaches to estimating the cost of equity: a global Capital Asset Pricing Model (CAPM), or a local CAPM. The global CAPM is commonly used by banks, whereas the local CAPM is more commonly used by regulatory authorities (e.g. ANTT, the Brazil transport regulator; ARCEP (France); CMT (Spain); ComReg (Ireland); Ofcom (United Kingdom); and PTS (Sweden)). Estimating the CAPM using local parameters is possible according to the availability of stable data. Both methodologies have pros and cons, however, using the local CAPM is recommended when data is available, since it is more transparent and tends to better reflect the local market.

The global CAPM attempts to construct a true picture of the country using international data. It is recommended in cases of limited availability of information on the domestic market and/or information on telecommunications assets listed on a stock exchange in the country in question.

An alternative way of capturing uncalculated risks would be to add to the global CAPM other factors that could represent political, regulatory and other risks – however, at present these models are still experimental. An Internet search quickly reveals a wide variety of data that can assist in calculating the CAPM³⁴ such as that presented in Table 7.

Table 7: Pros and cons of the local vs. global CAPM

	Local CAPM	Global CAPM
Pros	<ul style="list-style-type: none"> - Transparency. - It reflects the perspective of the local market. 	<ul style="list-style-type: none"> - It does not depend on local databases. It uses benchmarks. - It uses more mature economic data.
Cons	<ul style="list-style-type: none"> - It depends on database availability. - It is necessary a stable macroeconomic scenario. 	<ul style="list-style-type: none"> - Benchmarks comparability. - The use of country risk, with a large variability. - The leverage and deleveraging process among countries in not accurate.

Source: ITU

The local CAPM uses internal data. The main advantages of using the local CAPM are the transparency conferred by the wide acceptance of this methodology by the academic community and the market, and the accurate view of the local market this approach offers. Conversely, disadvantages might include a lack of available databases and/or the lack of a stable domestic macroeconomic scenario.

In countries where there is long-term economic stability, long-term financial indexes and stable assets, it is recommended to adopt the local CAPM methodology.

³⁴ A useful suggestion is offered here: http://people.stern.nyu.edu/adamodar/New_Home_Page/home.htm

Converting nominal WACC to real WACC

Once WACC has been estimated in nominal values the inflationary value for the relevant period should be discounted to arrive at the indicator in real terms, using the so-called Fisher equation:

$$WACC_{Real} = \frac{(1 + WACC_{Nominal})}{(1 + \pi)} - 1$$

where:

$WACC_{Real}$ is the real WACC

$WACC_{Nominal}$ is the nominal WACC

π is the inflation rate

Simply subtracting the inflationary value from the nominal WACC will not yield the correct result, tending to overestimate the real rate – although the error will be small in cases where interest rates and inflation are relatively low.

Using forward-looking inflation estimates is recommended; ideally, estimates should be for a time period equal to the maturity of the risk-free bond, although in practice this is not always possible because of the limited time horizon of inflation forecasts.

Estimating the WACC through a global CAPM method

Cost of Equity (Ke)	
Country Risk Premium:	2.63%
Risk-free rate:	2.66%
Beta:	0.99
Market Risk Premium (MRP):	8.49%
Cost of Equity Estimation (Ke)	13.92%
Cost of debt (Kd)	
Risk-free bond	6.40%
Spread	6.89%
Cost of debt estimation:	6.84%
Corporate Tax Rate	34%
Cost of debt estimation 'after tax':	4.51%
D/(D+E)	
D/(D+E):	30%
E/(D+E):	70%
TOTAL:	100%
Inflation Rate	
US Inflation goal:	2.0%
Local Inflation goal	4.0%
WACC	
Weighted Cost of Equity:	9.74%
Weighted Cost of Debt:	1.35%
WACC nominal	11.10%
WACC real:	6.82%

Country Risk Premium: 2.63% Country Risk Premium from Damodaran

Risk-free rate: Is the return of the US 10Y bond.

Beta:

	E/(D+E)	D/(D+E)	TOTAL	Tax	Unlevered beta	Levered beta
	70%	30%	100%	34.0%	0.768	0.985

Unlevered beta: Beta, Unlevered beta and other risk measures - Emerging Markets from Damodaran

Market Risk Premium (MRP):

Historical market risk premium

	S&P500	US 10Y	MRP
15 years (2004 - 2018)	8.52%	0.97%	8.49%

Risk-free bond: 6.40% Is the return of a risk-free country bond on a specific date.

Spread28/01/2019

Bonds	Volume	Value	Individual Spread	Spread
Operator A	151,500	10,000	4.3%	6.89%
Operator B	110,000	10,000	4.0%	
Operator C	523,525	1,000	13.4%	
Operator D	100,000	10,000	3.2%	
Operator A	1,500,000	1,000	2.9%	
Operator B	100,000	10,000	3.9%	
Operator C	2,000	10,000	40.0%	
Operator D	150,000	1,000	11.5%	
Operator A	200,000	10,000	8.3%	
Operator B	2,720	234,700	26.1%	

Source: ITU
Note: The values used are illustrative.

Estimating the net present value (NPV) of broadband infrastructure projects

As detailed in the section on business planning principles, calculating net present value is the most important output of the business planning process for regulators and policymakers. It combines CAPEX, OPEX, revenues and cash flow estimation throughout the years of network deployment and service provision into an economic equation designed to help accurately evaluate the economic sustainability and attractiveness of an infrastructure project, as well as helping quantify the lack of national broadband infrastructure.

To promote a better understanding of how to calculate the NPV of an infrastructure project, the diagrammes presented in Figure 14 and 15 break the calculation into six steps, which will be explained more fully in the following section.

Figure 14: Steps 1 to 4 of the NPV calculation

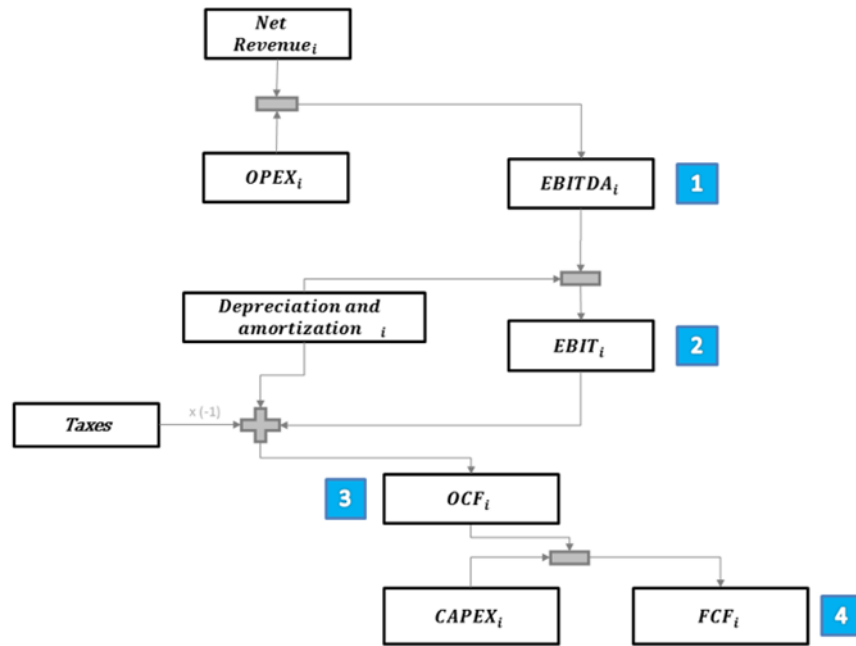

Source: ITU

Figure 15: Steps 5 and 6 of the NPV calculation

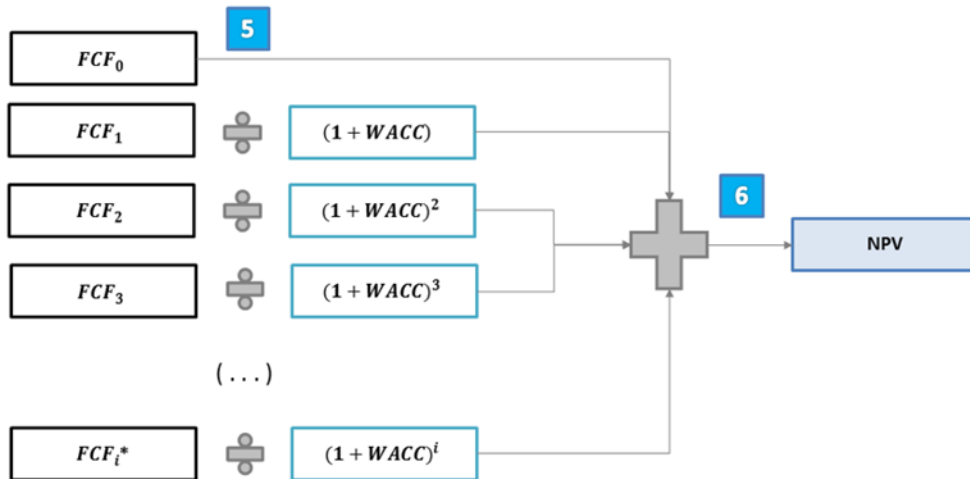

* Calculated with the Residual Value, non depreciated

Source: ITU

The first step in an infrastructure project NPV calculation is estimating the *earnings before interest, taxes, depreciation and amortization* (EBITDA) for each year of operation. This can be calculated simply by taking the difference between the net revenue and OPEX estimated year by year, according to the methodologies already presented in this toolkit.

Step two consists in calculating *earnings before interest and taxes* (EBIT), which entails subtracting the estimated depreciation and amortization (DA) from the EBITDA³⁵. The calculation of DA for a given year i of operation can be made by using the formula below:

$$DA_i = \begin{cases} \sum_{k=1}^i \frac{CAPEX_k}{t}, & \text{if } i \leq t \\ \sum_{k=i-t+1}^i \frac{CAPEX_k}{t}, & \text{if } i > t \end{cases}$$

where:

DA_i is the depreciation and amortization in a given year i of operation

$CAPEX_k$ is the CAPEX estimated for a given year k of operation

t is the average life span (in years) of the assets (CAPEX) or the number of years of depreciation established by local accounting rules

i is a given year of operation, for example, year 1, 2, 3, etc.

The third step in NPV calculation is to estimate the operating cash flow for each year, taking the difference between the EBITDA and the sum of taxes estimated for each year where EBIT is positive. Calculation of the sum of taxes by year can be made using the formula below:

$$T_i = \text{Max}(0; EBIT_i \times TR_{local})$$

where:

T_i is the total sum of taxes to be considered in the FCF of a given year i

$EBIT_i$ is the earnings before interest and taxes for a given year i

TR_{local} is the local tax rate charged on the profits of the operator whose plan is being evaluated.

The fourth step in infrastructure project NPV calculation is to obtain the free cash flow (FCF) result for each year of operation, simply by calculating the difference between the operating cash flow (OCF) and the total CAPEX invested in a given year i .

Having obtained the FCF result for each year of operation, steps five and six consist in calculating the NPV of the FCF results for each year of operation, and finally adding these together to obtain the total infrastructure project NPV. These two last steps can be performed by using the formula below:

$$NPV = \sum_1^z \frac{FCF_i}{(1+WACC)^i}$$

where:

NPV is the total net present value of the infrastructure project

³⁵ The percentage and period of depreciation/amortization may vary in each country.

FCF_i is the free cash flow result of a given year i ³⁶

WACC is the weighted average capital cost

z is the total number of years of operation being considered in the evaluation of the infrastructure project.

Net present value (NPV) calculation

The following example illustrates the calculation of the Net Present Value of a given infrastructure project.

Net Present value (NPV) Calculation										
Year	2019	2020	2021	2022	2023	2024	2025	2026	2027	2028
Net Revenue	\$ 90,958	\$ 1,320,680	\$ 4,347,379	\$ 7,672,031	\$ 9,387,107	\$ 10,152,234	\$ 10,807,641	\$ 11,537,279	\$ 12,356,841	\$ 13,264,945
OPEX	\$ 556,799	\$ 1,265,662	\$ 3,026,254	\$ 4,956,718	\$ 5,948,765	\$ 6,388,380	\$ 6,764,155	\$ 7,182,756	\$ 7,653,129	\$ 8,174,287
CAPEX	\$ 13,626,755	\$ 991,972	\$ 2,640,051	\$ 2,977,650	\$ 1,688,348	\$ 936,385	\$ 867,603	\$ 948,811	\$ 1,044,085	\$ 1,139,274
EBITDA	\$ -465,841	\$ 55,018	\$ 1,321,125	\$ 2,715,314	\$ 3,438,343	\$ 3,763,854	\$ 4,043,486	\$ 4,354,523	\$ 4,703,712	\$ 5,090,658
Depreciation (e.g. 5 years)	\$ 2,725,351	\$ 2,923,745	\$ 3,451,756	\$ 4,047,285	\$ 4,384,955	\$ 1,846,881	\$ 1,822,007	\$ 1,483,759	\$ 1,097,046	\$ 987,232
EBIT	\$ -3,191,192	\$ -2,868,727	\$ -2,130,631	\$ -1,331,972	\$ -946,612	\$ 1,916,973	\$ 2,221,479	\$ 2,870,764	\$ 3,606,666	\$ 4,103,426
Taxes (e.g. 25% of EBIT)	\$ -	\$ -	\$ -	\$ -	\$ -	\$ 479,243	\$ 555,370	\$ 717,691	\$ 901,666	\$ 1,025,857
OCF	\$ -465,841	\$ 55,018	\$ 1,321,125	\$ 2,715,314	\$ 3,438,343	\$ 3,284,611	\$ 3,488,116	\$ 3,636,832	\$ 3,802,046	\$ 4,064,801
FCF	\$ -14,092,596	\$ -936,954	\$ -1,318,926	\$ -262,336	\$ 1,749,995	\$ 2,348,226	\$ 2,620,513	\$ 2,688,021	\$ 2,757,961	\$ 2,925,527
NPV (e.g. WACC of 5%)	\$ -14,092,596	\$ -892,337	\$ -1,196,305	\$ -226,616	\$ 1,439,725	\$ 1,839,896	\$ 1,955,467	\$ 1,910,326	\$ 1,866,696	\$ 1,885,821
Total NPV	(5,509,921)									

Source: ITU

Note: The values used are illustrative.

7 Financing mechanisms to enable broadband infrastructure projects

Policymakers aiming to enable broadband infrastructure projects, which are by nature highly capital intensive and involve huge sums for project development and licensing, network deployment and administrative and operational costs, should perform an in-depth study of the financing alternatives that could (or should) be offered by the government, the availability of private credit in the domestic market for the project, and the necessary conditions that would increase the project economic attractiveness to foreign capital.

Especially in cases where an infrastructure project estimated NPV points to a low attractiveness vis-à-vis network deployment and service provision in zones which the government has prioritized for telecommunications infrastructure investment, having a clear picture of the financing alternatives available will be key to evaluating the potential success or failure of a public policy.

In order to better understand the financing mechanisms related to large broadband infrastructure projects and to identify the main actors and the necessary investment conditions, it is useful to split a typical telecommunications project into three costing phases:

- i) project planning and licensing;
- ii) infrastructure deployment;
- iii) service provision.

³⁶ The remaining residue of non-depreciated assets must be added to the FCF of the last year of operation; this can be calculated simply by the difference between the sum of CAPEX and the sum of depreciation and amortization calculated throughout the year of operation.

For each of these phases we will now consider some typical infrastructure project financing mechanisms; principally equity, public and private financing, and the issuing of stocks and debentures.

Figure 16: Distribution of typical infrastructure project financing mechanisms

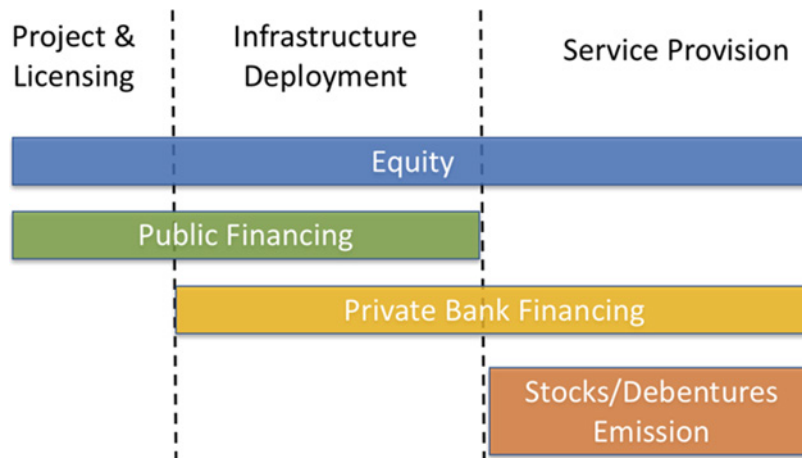

Source: ITU

7.1 Project and licensing financing mechanisms

The first costing phase of a broadband infrastructure project from a company perspective entails comprehensive market studies, business planning, network designing and dimensioning, and obtaining the required government licences to operate, which – depending on the project – may involve participation in public auctions to obtain costly licences (to access and use licensed spectrum, for example).

This costing phase, when there is no cash flow generation or even any network infrastructure deployed, is commonly financed by equity or public financing, due to the difficulty of accessing credit through the usual financing channels given the high level of risk involved. A potential operator interested in providing broadband in regions targeted by public policy initiatives can contract market studies in order to help make an informed decision on the economic sustainability of an infrastructure project being offered by the government. Indeed, the government itself can even contract these studies and publish the results in order to stimulate interest and attract as many potential operators as possible.

As has been seen in many markets, the acquisition of spectrum licences for mobile 4G LTE wireless broadband networks has typically cost millions or even billions of USD. Payment of these licence fees used to be made using equity – but to avoid expending equity which could be channelled towards network infrastructure investment, public financing of the licence fees (to be paid over the years of operation with low interest rates) offers an alternative approach which could attract not just large operators already established at the national level but also smaller companies seeking to enter the mobile broadband market.

The availability of this kind of public financing represents a lower entrance barrier and increases the economic attractiveness of a telecommunication infrastructure project. In addition, scheduling a single annual payment of licence fees covering a whole year of operation can free up cash for interested companies to invest more intensively in network deployment.

Finally, despite the usual higher cost of credit in this first costing phase, operators already established in the local telecommunication market that have a strong relationship with the private banking market may be able obtain credit for this costing phase at reasonable interest rates.

7.2 Infrastructure deployment financing mechanisms

The network infrastructure deployment costing phase is the more capital-intensive phase in broadband projects. For this reason, a combination of financing mechanisms may be used to support the roll-out of passive and active infrastructure installation throughout the municipalities targeted by the public policy.

The use of equity in this costing phase is certainly one option, but it is perhaps surprisingly less common when compared with other financing mechanisms. This is generally because of the higher cost of equity compared to the interest rates of public and private credit financing geared to investment in infrastructure projects. For example, most governments give tax incentives for investment credit, allowing the private banking market to offer investment credit at lower interest rates. Governments themselves even offer investment credit at subsidized interest rates, through development banks aiming to encourage the build up of national infrastructure.

For these reasons, investment credit offered by the public and private banking market represents the most important financing mechanism used to support the costly phase of network deployment, although this kind of financing mechanism inevitably favours long-term economically sustainable infrastructure projects. Indeed, access to the private investment credit market usually requires comprehensive and rigorous business planning that proves the economic viability of the infrastructure project to be financed.

However, many infrastructure projects included in public policy initiatives are by their very nature economically unattractive, otherwise their inclusion would produce unwanted crowding out effects, i.e., they would hinder private investment by replacing such investment with public investment. For such economically unattractive infrastructure projects, government subsidies can be the most important financing mechanism offered. Such subsidies may be applied directly or indirectly to the local telecommunication market in order to improve project attractiveness.

Direct subsidies can be made available, for example, through universal service obligation funds created specifically to foster telecommunication development, or even through specific tax exemptions applied to operators who engage in the project. Indirect subsidies can be made available by lowering spectrum licensing fees in exchange for a commitment to deploy and provide service in unattractive areas, for example, or by converting an operator fines backlog into obligations to deploy and provide broadband services in unattractive regions.

Finally, some operators may use their engagement in new broadband projects to raise market expectations and so obtain financing from the issuing of stocks and debentures, but this financing mechanism is more common in the service provision costing phase, for the reasons presented in section 7.3.

7.3 Service provision financing mechanisms

The final and longest costing phase of a broadband project starts with network operation and service provision. This phase is characterized by intense cash generation and the need for floating capital to support administrative, operational and maintenance costs, as well as continuous investments in network expansion and modernization.

Given that floating capital is usually expensive in credit markets, the use of equity for this purpose is quite common. On the other hand, the opportunity cost of allocating equity to support the cash flow of a long-term operation tends to increase quickly, making other financing mechanisms such as issuing stocks and debentures better long-term financing alternatives.

In fact, a healthy operation generating robust and growing revenues may attract investors aiming to get fair long-run remuneration from debt bonds. Thus, the healthier the operation cash flow, the more attractive it will be for a company to secure financing through the issuing of stocks and debentures, since the economic sustainability of the operation will be reflected in a higher stock valuation and lower interest rates charged on debt bonds.

While it is generally costly to secure private banking finance to support the floating capital needed in this phase, it is true that some multinational operators may get access to the international credit market and obtain lower interest rates for financing service provision. But in most cases, attracting international capital for broadband deployment will prove a challenge, given the many risks involved – for example, financial cost increase risk, demand frustration risk, and exchange rate fluctuation risk.

Indeed, it can be advisable for governments seeking to promote broadband network deployment in underserved areas to offer some mechanism to mitigate demand risk – for example financial guarantees to the operator to shore up declining revenues in the case of a no-fault fall in demand, or linking the amount charged as an annual licensing fee with the operator annual revenue-generating capacity.

Exchange rate fluctuation risk occurs when the currency in which the financing was obtained (whether the operator equity, or third party equity) differs from the currency in which the costs of the venture are to be paid. One mechanism governments commonly use to mitigate this risk is the contracting of an exchange hedge, in order to cushion the impact of significant exchange rate fluctuation on the operator business plan.

The risk of increased financial costs during the project is due to the impact of large variations in the interest rate of the economy on the interest rate of the financing contracted within the country. One way governments can mitigate this risk is to contract interest rate swaps, which has the effect of boosting the economic attractiveness of the venture to foreign capital.

8 Conclusions

ICT infrastructure is the basis of today's digital economy, and offers enormous potential to advance progress towards the UN Sustainable Development Goals and improve people's lives in fundamental ways.

Designing a business plan aimed at bringing ICT networks to underserved, remote and rural areas represents a considerable challenge for policymakers, who need to consider installation, operation, migration and further development of national and cross-border infrastructure, as well as the relative costs associated with network installation and deployment, and optimal strategies for financing the necessary investments.

This ICT Infrastructure Toolkit has sought to address each of the key considerations and best-practice mechanisms for planning; estimating costs, demand and revenues; and evaluating financing options, with a particular focus on projects serving economically unattractive areas. The target public of this toolkit is ITU Member States looking for guidance on how to elaborate credible, coherent and well-founded business plans to broaden network coverage and ensure ongoing sustainability.

With these guidelines, policymakers and regulators can accurately identify the degree of economic unfeasibility of a project through calculating its net present value (NPV).

Policymakers aiming to enable broadband infrastructure projects, which are typically highly capital intensive, should perform an in-depth study of potential financing alternatives that the government could offer, as well as the availability of private credit in the domestic market, in order to clearly understand the necessary conditions that could increase a project economic attractiveness to foreign capital. This is particularly important when the estimated project NPV points to non-attractiveness of the network deployment and service provision in areas which the government has classified as priority for increased investment in telecommunication infrastructure.

Finally, let us once again stress our four foundational principles for all public policy business plans:

- use as much open data as possible;
- use studies from recognized, internationally credible sources;

- use auditable tools;
- be conservative when making estimates.

These recommendations are essential to conferring credibility on the entire process.

Considering the huge gaps in ICT infrastructure that still persist in many countries – even some of the world’s most developed nations – the authors hope that this toolkit will play a significant role in helping bring broadband to all, and contribute to the realization of the UN Sustainable Development Goals.

List of acronyms

ARPU	Average Revenue Per User
CAPM	Capital Asset Pricing Model
CAPEX	Capital Expenditure
CPE	Customer Premises Equipment
CRP	Country Risk Premium
DWDM	Dense Wavelength Division Multiplexing
DSL	Digital Subscriber Line
EBIT	Earnings Before Interest and Taxes
EBITDA	Earnings before interest, taxes, depreciation and amortization
FTTH	Fibre to the home
FTTO	Fibre to the office
4G	Fourth Generation Standard
FCF	Free Cash Flow
FAC	Full Allocated Cost
GDP	Gross Domestic Product
GDPPC	Gross Domestic Product Per Capita
HC	Home-connected
HP	Home-passed
HSPA	High Speed Packet Access
HFC	Hybrid Fibre Coax
ICT	Information and Communications Technology
IEEE	Institute of Electrical and Electronics Engineers
IRR	Internal Rate of Return
LTE	Long Term Evolution
MOU	Minutes of Usage
MRP	Market Risk Premium
NPV	Net Present Value
OCF	Operating Cash Flow
OPEX	Operational Expenditure
ODN	Optical Distribution Network
OLT	Optical Line Terminal
ONT	Optical Network Terminal
OECD	Organisation for Economic Co-operation and Development
PPP	Public Private Partnership

QAM	Quadrature Amplitude Modulation
RAN	Radio Access Network
R&D	Research and Development
ROI	Return on Investment
RPM	Revenue per Minute
SDH	Synchronous Digital Hierarchy)
3G	Third Generation Standard
TCO	Total Cost of Operation
USF	Universal Service Fund
WACC	Weighted Average Cost of Capital
WCDMA	Wide-Band Code-Division Multiple Access

Bibliography

- Berk, J., DeMarzo, P. & Stangeland, D. (2015) *Corporate Finance* (3rd Canadian ed.), Pearson Canada (Toronto) ISBN 978-0133552683, p. 64.
- Blume, M. (1979) *Betas and Their Regression Tendencies: Some Further Evidence*, *Journal of Finance*, Volume 34 Issue 1, 265-67.
- Brown, S.J & Warner, J.B. (1980) *Measuring Security Price Performance*, *Journal of Financial Economics*, Volume 8 Issue 3, 205-58.
- Brown, S.J & Warner, J.B. (1985) *Using Daily Stock Returns: The Case of Event Studies*, *Journal of Financial Economics*, Volume 14 Issue 1, 3-31.
- Bruner, R.F., Eades, K.M., Harris, R.S. & Higgins, R.C. (1998) *Best Practices in Estimating the Cost of Capital: Survey and Synthesis*, *Financial Practice and Education*, Spring/Summer, 13-28.
- Cadman, R. and Dineen, C. (2008) *Price and income elasticity of demand for broadband subscriptions: A cross-sectional model of OECD countries*, SPC Network, https://spcnetwork.eu/uploads/Broadband_Price_Elasticity.pdf.
- Cardona, M. et al. (2009) *Demand estimation and market definition for broadband Internet services*, *Journal of Regulatory Economics*, Volume 35 Issue 1, 70-95.
- Cisco Systems Inc., (2017) *Cisco Visual Networking Index Global Mobile Data Traffic Forecast Update, 2016–2021*, white paper, <https://bit.ly/2vu69MQ>.
- Copeland, T.E., Koller, T., & Murrin, J. (1999) *Valuation: Measuring and Managing the Value of Companies*, John Wiley and Sons.
- Damodaran, A. (2001) *Corporate Finance: Theory and Practice*, (2nd edition) John Wiley and Sons, New York.
- Damodaran, A. (1999) *The Dark Side of Valuation: Firms with No Earnings, No History and No Comparables*, NYU Working Paper n^o FIN-99-022. ,
- Dimson, E. (1979) *Risk Measurement When Shares are Subject to Infrequent Trading*, *Journal of Financial Economics*, Volume 7 Issue 2, 197-226.
- Fildes, R. & Kumar, V (2002) *Telecommunications demand forecasting – a review*, *International Journal of Forecasting*, Volume 18 Issue 4, 489-522.
- Garbacz, C. & Thompson, H. G. (2007) *Demand for telecommunication services in developing countries*, *Telecommunications Policy*, Volume 31 Issue 5, 276-289.
- ITU Broadband Maps (2019)* available at: <https://www.itu.int/en/ITU-D/Technology/Pages/InteractiveTransmissionMaps.aspx>.
- ITU ICT-Eye database* is available at <http://www.itu.int/net4/itu-d/icteye/Default.aspx>.
- ITU Infrastructure Development Portal* available at <https://www.itu.int/en/ITU-D/Regulatory-Market/Pages/InfrastructurePortal.aspx>.
- ITU Key 2005 – 2018 ICT Data*, available at https://www.itu.int/en/ITU-D/Statistics/Documents/statistics/2018/ITU_Key_2005-2018_ICT_data_with%20LDCs_rev27Nov2018.xls.
- ITU-T Recommendations Series G: Transmission systems and media, digital systems and networks*, available at <https://www.itu.int/rec/T-REC-G/en>

Mitscenkov, A., Kantor, M., Casier, K., Lannoo, B., Wajda, K., Chen, J., & Wosinska, L. (2013) *Geometric versus Geographic Models for the Estimation of an FTTH Deployment*, Telecommunication Systems, Volume 54, 113–127, <https://doi.org/10.1007/S11235-013-9720-3>.

Hamada, R.S. (1972) *The Effect of the Firm's Capital Structure on the Systematic Risk of Common Stocks*, Journal of Finance, Volume 27, 435-452.

Hausman, J. A. & Ros, A. J. (2013) *An econometric assessment of telecommunications prices and consumer surplus in Mexico using panel data*, Journal of Regulatory Economics, Volume 43 Issue 3.

Katz, Raul L. (2009) *Estimating broadband demand and its economic impact in Latin America*, proceedings of the 3rd Acorn-Redecom Conference, Mexico City.

Khan, M.Y. (1993) *Theory & Problems in Financial Management*, McGraw Hill Higher Education, ISBN 978-0-07-463683-1.

Knoll, T. M. (2012) *LTE Network Design from a Techno-Economic Perspective*, <https://bit.ly/2DcitnT>

Landsburg, S. E. (2001) *Price Theory and Applications*, South-Western, 5th edition.

Gregory Mankiw, N. (2000) *Principles of Microeconomics*. South-Western, 2nd edition.

Salcedo, A. & Kuhlmann, F. (2016) *A model to estimate the broadband and Internet access demand for typical Mexican rural communities*, Communication Policy Research Latin America, Volume 10.

Scholes, M. & Williams, J.T. (1977) *Estimating Betas from Nonsynchronous Data*, Journal of Financial Economics, Volume 5, Issue 3, 309-27.

Paolini, M. (2012) *The economics of small cells and Wi-Fi offload*, Senza Fili Consulting.

Roberts, M. (2014) *Smartphone use transforming with the rise of 4G and WiFi*, Informa Telecoms & Media.

Sobolewski, M. & Kopczewski, T. (2017) *Estimating demand for fixed-line telecommunication bundles*, Telecommunications Policy, Volume 41 Issue 4, 227-241.

International Telecommunication Union (ITU)
Telecommunication Development Bureau (BDT)
Office of the Director
Place des Nations
CH-1211 Geneva 20 – Switzerland
Email: bdtdirector@itu.int
Tel.: +41 22 730 5035/5435
Fax: +41 22 730 5484

**Deputy to the Director and
Director, Administration and
Operations Coordination
Department (DDR)**
Email: bdtdputydir@itu.int
Tel.: +41 22 730 5784
Fax: +41 22 730 5484

**Infrastructure Enabling
Environment and
e-Applications Department (IEE)**
Email: bdtiee@itu.int
Tel.: +41 22 730 5421
Fax: +41 22 730 5484

**Innovation and Partnership
Department (IP)**
Email: bdtip@itu.int
Tel.: +41 22 730 5900
Fax: +41 22 730 5484

**Project Support and Knowledge
Management Department (PKM)**
Email: bdtpkm@itu.int
Tel.: +41 22 730 5447
Fax: +41 22 730 5484

Africa

Ethiopia
**International Telecommunication
Union (ITU)**
Regional Office
P.O. Box 60 005
Gambia Rd., Leghar ETC Building
3rd floor
Addis Ababa – Ethiopia

Email: itu-addis@itu.int
Tel.: +251 11 551 4977
Tel.: +251 11 551 4855
Tel.: +251 11 551 8328
Fax: +251 11 551 7299

Cameroon
**International Telecommunication
des télécommunications (UIT)**
Bureau de zone
Immeuble CAMPOST, 3^e étage
Boulevard du 20 mai
Boîte postale 11017
Yaoundé – Cameroun

Email: itu-yaounde@itu.int
Tel.: + 237 22 22 9292
Tel.: + 237 22 22 9291
Fax: + 237 22 22 9297

Senegal
**Union internationale des
télécommunications (UIT)**
Bureau de zone
19, Rue Parchappe x Amadou
Assane Ndoye
Immeuble Fayçal, 4^e étage
B.P. 50202 Dakar RP
Dakar – Sénégal

Email: itu-dakar@itu.int
Tel.: +221 33 849 7720
Fax: +221 33 822 8013

Zimbabwe
**International Telecommunication
Union (ITU)**
Area Office
TelOne Centre for Learning
Corner Samora Machel and
Hampton Road
P.O. Box BE 792 Belvedere
Harare – Zimbabwe

Email: itu-harare@itu.int
Tel.: +263 4 77 5939
Tel.: +263 4 77 5941
Fax: +263 4 77 1257

Americas

Brazil
**União Internacional de
Telecomunicações (UIT)**
Regional Office
SAUS Quadra 06, Bloco "E"
11^o andar, Ala Sul
Ed. Luis Eduardo Magalhães (Anatel)
70070-940 Brasília, DF – Brazil

Email: itubrasilia@itu.int
Tel.: +55 61 2312 2730-1
Tel.: +55 61 2312 2733-5
Fax: +55 61 2312 2738

Barbados
**International Telecommunication
Union (ITU)**
Area Office
United Nations House
Marine Gardens
Hastings, Christ Church
P.O. Box 1047
Bridgetown – Barbados

Email: itubridgetown@itu.int
Tel.: +1 246 431 0343/4
Fax: +1 246 437 7403

Chile
**Unión Internacional de
Telecomunicaciones (UIT)**
Oficina de Representación de Área
Merced 753, Piso 4
Casilla 50484, Plaza de Armas
Santiago de Chile – Chile

Email: itusantiago@itu.int
Tel.: +56 2 632 6134/6147
Fax: +56 2 632 6154

Honduras
**Unión Internacional de
Telecomunicaciones (UIT)**
Oficina de Representación de Área
Colonia Palmira, Avenida Brasil
Ed. COMTELCA/UIT, 4.º piso
P.O. Box 976
Tegucigalpa – Honduras

Email: itutegucigalpa@itu.int
Tel.: +504 22 201 074
Fax: +504 22 201 075

Arab States

Egypt
**International Telecommunication
Union (ITU)**
Regional Office
Smart Village, Building B 147, 3rd floor
Km 28 Cairo – Alexandria Desert Road
Giza Governorate
Cairo – Egypt

Email: itucairo@itu.int
Tel.: +202 3537 1777
Fax: +202 3537 1888

Asia and the Pacific

Thailand
**International Telecommunication
Union (ITU)**
Regional Office
Thailand Post Training Center, 5th
floor,
111 Chaengwattana Road, Laksi
Bangkok 10210 – Thailand

Mailing address
P.O. Box 178, Laksi Post Office
Laksi, Bangkok 10210 – Thailand

Email: itubangkok@itu.int
Tel.: +66 2 575 0055
Fax: +66 2 575 3507

Indonesia
**International Telecommunication
Union (ITU)**
Area Office
Sapta Pesona Building, 13th floor
Jl. Merdan Merdeka Barat No. 17
Jakarta 10001 – Indonesia

Mailing address:
c/o UNDP – P.O. Box 2338
Jakarta 10001 – Indonesia

Email: itujakarta@itu.int
Tel.: +62 21 381 3572
Tel.: +62 21 380 2322
Tel.: +62 21 380 2324
Fax: +62 21 389 05521

CIS countries

Russian Federation
**International Telecommunication
Union (ITU)**
Regional Office
4, Building 1
Sergiy Radonezhsky Str.
Moscow 105120
Russian Federation

Mailing address:
P.O. Box 25 – Moscow 105120
Russian Federation

Email: itumoskow@itu.int
Tel.: +7 495 926 6070
Fax: +7 495 926 6073

Europe

Switzerland
**International Telecommunication
Union (ITU)**
**Telecommunication Development
Bureau (BDT)**
Europe Unit (EUR)
Place des Nations
CH-1211 Geneva 20 – Switzerland
Switzerland
Email: eurregion@itu.int
Tel.: +41 22 730 5111

International Telecommunication Union
Telecommunication Development Bureau
Place des Nations
CH-1211 Geneva 20
Switzerland

ISBN: 978-92-61-28881-5



9 789261 288815

Published in Switzerland
Geneva, 2019

Photo credits: Shutterstock